

มาตรฐานผลิตภัณฑ์อุตสาหกรรม

THAI INDUSTRIAL STANDARD

มอก. 1470–2549

ECE Regulation No. 48

02 series of amendments

**การติดตั้งอุปกรณ์ส่องสว่าง
และอุปกรณ์แสงสัญญาณสำหรับยานยนต์**

**INSTALLATION OF LIGHTING AND
LIGHT-SIGNALLING DEVICES FOR MOTOR VEHICLES**

สำนักงานมาตรฐานผลิตภัณฑ์อุตสาหกรรม

กระทรวงอุตสาหกรรม

ICS 43.040.20

ISBN 987-974-292-305-1

มาตรฐานผลิตภัณฑ์อุตสาหกรรม
การติดตั้งอุปกรณ์ส่องสว่าง
และอุปกรณ์แสงสัญญาณสำหรับยานยนต์

มอก. 1470—2549

สำนักงานมาตรฐานผลิตภัณฑ์อุตสาหกรรม
กระทรวงอุตสาหกรรม ถนนพระรามที่ 6 กรุงเทพฯ 10400
โทรศัพท์ 0 2202 3300

ประกาศในราชกิจจานุเบกษา ฉบับประกาศและงานทั่วไป เล่ม 124 ตอนพิเศษ 28 ง
วันที่ 12 มีนาคม พุทธศักราช 2550

มาตรฐานผลิตภัณฑ์อุตสาหกรรมการติดตั้งอุปกรณ์ส่องสว่างและอุปกรณ์แสงสัญญาณสำหรับยานยนต์ นี้ได้ประกาศครั้งแรกเป็นมาตรฐานผลิตภัณฑ์อุตสาหกรรมการติดตั้งอุปกรณ์ส่องสว่างและอุปกรณ์ให้สัญญาณด้วยแสง: เฉพาะด้านความปลอดภัย มาตรฐานเลขที่ มอก. 1470-2540 ในราชกิจจานุเบกษา เล่ม 115 ตอนที่ 97ง วันที่ 3 ธันวาคม พุทธศักราช 2540 ต่อมาพิจารณาเห็นสมควรแก้ไขปรับปรุงสาระสำคัญของมาตรฐานผลิตภัณฑ์อุตสาหกรรมนี้ เพื่อให้สอดคล้องตามมาตรฐานระหว่างประเทศที่เป็นที่ยอมรับในปัจจุบัน จึงได้แก้ไขปรับปรุงโดยยกเลิกมาตรฐานเดิม และกำหนดมาตรฐานนี้ขึ้นใหม่

มาตรฐานผลิตภัณฑ์อุตสาหกรรมนี้กำหนดขึ้นโดยรับ Economic Commission for Europe (ECE) Regulation No. 48 UNIFORM PROVISIONS CONCERNING THE APPROVAL OF VEHICLES WITH REGARD TO THE INSTALLATION OF LIGHTING AND LIGHT-SIGNALLING DEVICES ดังต่อไปนี้

1. Regulation No. 48 Revision 3
Incorporating all valid text up to:
Supplement 2 – Supplement 8 to the 02 series of amendments
Corrigendum 1 and Corrigendum 2 to Revision 2 of the Regulation
Corrigendum 1 to Supplement 2 to the 02 series of amendments
Corrigendum 1 to Supplement 2 to the original version of the Regulation
2. Regulation No. 48 Revision 3 – Amendment 1
Supplement 9 to the 02 series of amendments
3. Regulation No. 48 Revision 3 – Erratum
4. Regulation No. 48 Revision 3 – Erratum 4
5. Regulation No. 48 Revision 3 – Corrigendum 5
Corrigendum 1 to Supplement 8 to the 02 series of amendments
6. Regulation No. 48 Revision 3 – Amendment 2
Supplement 10 to the 02 series of amendments
7. Regulation No. 48 Revision 3 – Amendment 3
Supplement 11 to the 02 series of amendments
8. Regulation No. 48 Revision 3 – Amendment 4
Supplement 12 to the 02 series of amendments

มาใช้ในระดับเหมือนกันทุกประการ (identical) เฉพาะสาระสำคัญทางวิชาการซึ่งแสดงถึงข้อกำหนดคุณลักษณะทั่วไป และข้อกำหนดคุณลักษณะของแต่ละอุปกรณ์ สำหรับข้อกำหนดด้านการรับรองหรือการดำเนินการต่างๆ ที่เกี่ยวข้อง ให้เป็นไปตามพระราชบัญญัติมาตรฐานผลิตภัณฑ์อุตสาหกรรม โดยสำนักงาน มาตรฐานผลิตภัณฑ์อุตสาหกรรมจะประกาศกำหนดหลักเกณฑ์การรับรอง ต่อไป

คณะกรรมการมาตรฐานผลิตภัณฑ์อุตสาหกรรมได้พิจารณามาตรฐานนี้แล้ว เห็นสมควรเสนอรัฐมนตรีประกาศตาม มาตรา 15 แห่งพระราชบัญญัติมาตรฐานผลิตภัณฑ์อุตสาหกรรม พ.ศ. 2511



ประกาศกระทรวงอุตสาหกรรม

ฉบับที่ 3550 (พ.ศ. 2549)

ออกตามความในพระราชบัญญัติมาตรฐานผลิตภัณฑ์อุตสาหกรรม

พ.ศ. 2511

เรื่อง ยกเลิกมาตรฐานผลิตภัณฑ์อุตสาหกรรม

การติดตั้งอุปกรณ์แสงสว่าง และอุปกรณ์ให้สัญญาณด้วยแสง : เฉพาะด้านความปลอดภัย

และกำหนดมาตรฐานผลิตภัณฑ์อุตสาหกรรม

การติดตั้งอุปกรณ์ส่องสว่าง และอุปกรณ์แสงสัญญาณสำหรับยานยนต์

โดยที่เป็นการสมควรปรับปรุงมาตรฐานผลิตภัณฑ์อุตสาหกรรม การติดตั้งอุปกรณ์แสงสว่าง และอุปกรณ์ให้สัญญาณด้วยแสง : เฉพาะด้านความปลอดภัย มาตรฐานเลขที่ มอก.1470-2540

อาศัยอำนาจตามความในมาตรา 15 แห่งพระราชบัญญัติมาตรฐานผลิตภัณฑ์อุตสาหกรรม พ.ศ. 2511 รัฐมนตรีว่าการกระทรวงอุตสาหกรรมออกประกาศยกเลิกประกาศกระทรวงอุตสาหกรรม ฉบับที่ 2407 (พ.ศ.2541) ออกตามความในพระราชบัญญัติมาตรฐานผลิตภัณฑ์อุตสาหกรรม พ.ศ.2511 เรื่อง กำหนดมาตรฐานผลิตภัณฑ์อุตสาหกรรม การติดตั้งอุปกรณ์แสงสว่าง และอุปกรณ์ให้สัญญาณด้วยแสง : เฉพาะด้านความปลอดภัย ลงวันที่ 7 กันยายน พ.ศ.2541 และออกประกาศกำหนดมาตรฐานผลิตภัณฑ์อุตสาหกรรม การติดตั้งอุปกรณ์ส่องสว่าง และอุปกรณ์แสงสัญญาณสำหรับยานยนต์ มาตรฐานเลขที่ มอก. 1470- 2549 ขึ้นใหม่ดังมีรายละเอียดต่อท้ายประกาศนี้ ทั้งนี้ ให้มีผลเมื่อพ้นกำหนด 120 วัน นับแต่วันถัดจากวันที่ประกาศในราชกิจจานุเบกษา เป็นต้นไป

ประกาศ ณ วันที่ 10 สิงหาคมพ.ศ. 2549

สุริยะ จรุงเรืองกิจ

รัฐมนตรีว่าการกระทรวงอุตสาหกรรม

มาตรฐานผลิตภัณฑ์อุตสาหกรรม การติดตั้งอุปกรณ์ส่องสว่าง และอุปกรณ์แสงสัญญาณสำหรับยานยนต์

ขอบข่าย

มาตรฐานผลิตภัณฑ์อุตสาหกรรมนี้ครอบคลุมข้อกำหนดคุณลักษณะทั่วไป และข้อกำหนดคุณลักษณะเฉพาะของแต่ละอุปกรณ์ของยานยนต์ตั้งแต่ 4 ล้อขึ้นไป ที่มีต้นกำลังขับเคลื่อนในตัว (power driven vehicle) ทั้งแบบที่มีตัวถังหรือไม่มีตัวถัง สำหรับใช้บนทางสาธารณะ และความเร็วออกแบบสูงสุดเกินกว่า 25 km/h รวมถึงของส่วนพ่วง มาตรฐานผลิตภัณฑ์อุตสาหกรรมนี้ไม่ครอบคลุมถึงยานยนต์ที่วิ่งบนราง เครื่องจักร และแทรกเตอร์ที่ใช้ในงานเกษตรหรือป่าไม้ และยานยนต์ที่ใช้ในงานโยธา

บทนิยาม

ความหมายของคำที่ใช้ในมาตรฐานผลิตภัณฑ์อุตสาหกรรมนี้ ให้เป็นไปตาม ECE Regulation No. 48

ข้อกำหนด

ข้อกำหนดคุณลักษณะทั่วไป และข้อกำหนดคุณลักษณะเฉพาะของแต่ละอุปกรณ์ในมาตรฐานผลิตภัณฑ์อุตสาหกรรมนี้ ให้เป็นไปตาม ECE Regulation No. 48 ข้อ 5. และ ข้อ 6.

การทดสอบ

การทดสอบและการหาค่าต่าง ๆ ตามมาตรฐานผลิตภัณฑ์อุตสาหกรรมนี้ ให้เป็นไปตาม ECE Regulation No. 48 ANNEX ต่าง ๆ

អង្គ. 1470—2549
ECE Regulation No. 48
02 series of amendments

Regulation No. 48

UNIFORM PROVISIONS CONCERNING THE APPROVAL OF VEHICLES WITH REGARD
TO THE INSTALLATION OF LIGHTING AND LIGHT-SIGNALLING DEVICES

CONTENTS

REGULATION	<u>Page</u>
1. Scope	5
2. Definitions	5
3. Application for approval	13
4. Approval	14
5. General specifications	15
6. Individual specifications.....	20
7. Modifications and extensions of the approval of the vehicle type or of the installation of its lighting and light-signalling devices	59
8. Conformity of production.....	60
9. Penalties for non-conformity of production	61
10. Production definitely discontinued.....	61
11. Names and addresses of the technical services responsible for conducting approval tests, and of administrative departments	61
12. Transitional provisions	61

ANNEXES

Annex 1 - Communication concerning the approval or refusal or extension or withdrawal of approval or production definitely discontinued of a vehicle type with regard to the installation of lighting and light-signalling devices, pursuant to Regulation No. 48

Annex 2 - Arrangements of approval marks

Annex 3 - Lamp surfaces, axis and centre of reference, and angles of geometric visibility

- Annex 4 - Visibility of a red lamp to the front and visibility of a white lamp to the rear
 - Annex 5 - States of loading to be taken into consideration in determining variations in the vertical orientation of the dipped-beam headlamp
 - Annex 6 - Measurement of the variation of dipped-beam inclination as a function of load
 - Annex 7 - Indication of the stated initial adjustment referred to in paragraph 6.2.6.1. of this Regulation
 - Annex 8 - The controls for the headlamp-levelling devices referred to in paragraph 6.2.6.2.2. of this Regulation
 - Annex 9 - Control of conformity of production
-

1. SCOPE

This Regulation applies to the approval of power-driven vehicles intended for use on the road, with or without bodywork, with not less than four wheels and a maximum design speed exceeding 25 km/h, and of their trailers, with the exception of vehicles which run on rails, agricultural or forestry tractors and machinery, and public works vehicles.

2. DEFINITIONS

For the purpose of this Regulation

2.1. "Approval of a vehicle" means the approval of a vehicle type with regard to the number and mode of installation of the lighting and light-signalling devices;

2.2. "Vehicle type with regard to the installation of lighting and light-signalling devices" means vehicles which do not differ in the essential respects mentioned in paragraphs 2.2.1. to 2.2.4.

The following are likewise considered not to be "vehicles of a different type": vehicles which differ within the meaning of paragraphs 2.2.1. to 2.2.4., but not in such a way as to entail a change in the kind, number, positioning and geometric visibility of the lamps and the inclination of the dipped-beam prescribed for the vehicle type in question, and vehicles on which optional lamps are fitted or are absent;

2.2.1. the dimension and the external shape of the vehicle;

2.2.2. the number and positioning of the devices;

2.2.3. the headlamp-levelling system;

2.2.4. the suspension system.

2.3. "Transverse plane" means a vertical plane perpendicular to the median longitudinal plane of the vehicle.

2.4. "Unladen vehicle" means a vehicle without driver, crew, passengers and load, but with a full supply of fuel, spare wheel and the tools normally carried.

2.5. "Laden vehicle" means a vehicle loaded to its technically permissible maximum mass, as stated by the manufacturer, who shall also fix the distribution of this mass between the axles in accordance with the method described in Annex 5.

2.6. "Device" means an element or an assembly of elements used to perform one or more functions;

- 2.7. Lamp" means a device designed to illuminate the road or to emit a light signal to other road users. Rear registration plate lamps and retro-reflectors are likewise to be regarded as lamps;
- 2.7.1. Light source */
- 2.7.1.1. "Light source" means one or more elements for visible radiation, which may be assembled with one or more transparent envelopes and with a base for mechanical and electrical connection.
- A light source may also be constituted by the extreme outlet of a light-guide, as part of a distributed lighting or light-signalling system not having a built-in outer lens;
- 2.7.1.1.1. "Replaceable light source" means a light source which is designed to be inserted in and removed from the holder of its device without tool;
- 2.7.1.1.2. "Non-replaceable light source" means a light source which can only be replaced by replacement of the device to which this light source is fixed;
- in case of a light source module: a light source which can only be replaced by replacement of the light source module to which this light source is fixed;
- 2.7.1.1.3. "Light source module" means an optical part of a device which is specific to that device, is containing one or more non-replaceable light sources, and is only removable from its device with the use of tool(s);
- 2.7.1.1.4. "Filament light source" (filament lamp) means a light source where the element for visible radiation is one or more heated filaments producing thermal radiation;
- 2.7.1.1.5. "Gas-discharge light source" means a light source where the element for visible radiation is a discharge arc producing electro-luminescence / fluorescence;
- 2.7.1.1.6. "Light-emitting diode" (LED) means a light source where the element for visible radiation is one or more solid state junctions producing injection-luminescence / fluorescence;
- 2.7.1.2. "Electronic light source control gear" means one or more components between supply and light source to control voltage and/ or electrical current of the light source;
- 2.7.1.2.1. "Ballast" means an electronic light source control gear between supply and light source to stabilise the electrical current of a gas-discharge light source;
- 2.7.1.2.2. "Ignitor" means an electronic light source control gear to start the arc of a gas-discharge light source.

- 2.7.2. "Equivalent lamps" means lamps having the same function and authorized in the country in which the vehicle is registered; such lamps may have different characteristics from those installed on the vehicle when it is approved on condition that they satisfy the requirements of this Regulation;
- 2.7.3. "Independent lamps" means devices having separate illuminating surfaces, 1/ separate light sources and separate lamp bodies;
- 2.7.4. "Grouped lamps" means devices having separate illuminating surfaces 1/ and separate light sources, but a common lamp body;
- 2.7.5. "Combined lamps" means devices having separate illuminating surfaces, 1/ but a common light source and a common lamp body;
- 2.7.6. "Reciprocally incorporated lamps" means devices having separate light sources or a single light source operating under different conditions (for example, optical, mechanical, electrical differences), totally or partially common illuminating surfaces 1/ and a common lamp body;
- 2.7.7. "Single-function lamp" means a part of a device which performs a single lighting or light-signalling function;
- 2.7.8. "Concealable lamp" means a lamp capable of being partly or completely hidden when not in use. This result may be achieved by means of a movable cover, by displacement of the lamp or by any other suitable means. The term "retractable" is used more particularly to describe a concealable lamp the displacement of which enables it to be inserted within the bodywork;
- 2.7.9. "Driving beam (main-beam) headlamp" means the lamp used to illuminate the road over a long distance ahead of the vehicle;
- 2.7.10. "Passing beam (dipped-beam) headlamp" means the lamp used to illuminate the road ahead of the vehicle without causing undue dazzle or discomfort to oncoming drivers and other road-users;
- 2.7.11. "Direction-indicator lamp" means the lamp used to indicate to other road-users that the driver intends to change direction to the right or to the left;

A direction-indicator lamp or lamps may also be used according to the provisions of Regulation No. 97;

1/ In the case of lighting devices for the rear registration plate and the direction-indicators (categories 5 and 6), replace by "light-emitting surface" in the absence of an illuminating surface.

2.7.12. "Stop lamp" means the lamp used to indicate to other road-users to the rear of the vehicle that its driver is applying the service brake.

The stop lamps may be activated by the application of a retarder or a similar device;

2.7.13. "Rear-registration plate illuminating device" means the device used to illuminate the space reserved for the rear registration plate; such a device may consist of several optical components;

2.7.14. "Front position lamp" means the lamp used to indicate the presence and the width of the vehicle when viewed from the front;

2.7.15. "Rear position lamp" means the lamp used to indicate the presence and width of the vehicle when viewed from the rear;

2.7.16. "Retro-reflector" means a device used to indicate the presence of a vehicle by the reflection of light emanating from a light source not connected to the vehicle, the observer being situated near the source;

For the purposes of this Regulation the following are not considered as retro-reflectors:

2.7.16.1. retro-reflecting number plates;

2.7.16.2. the retro-reflecting signals mentioned in the ADR (European Agreement concerning the international carriage of dangerous goods by road);

2.7.16.3. other retro-reflective markings which must be used to comply with national requirements for use as regards certain categories of vehicles or certain methods of operation;

2.7.17. "Retro-reflective marking" means an additional marking of characteristic shape and/or pattern intended to increase the visibility and easy identification of certain categories of vehicles and their trailers by the reflection of light emanating from a light source not connected to the vehicle, the observer being situated near the source

2.7.18. "Hazard warning signal" means the simultaneous operation of all of a vehicle's direction-indicator lamps to show that the vehicle temporarily constitutes a special danger to other road-users;

2.7.19. "Front fog lamp" means the lamp used to improve the illumination of the road in case of fog, snowfall, rainstorms or dust clouds;

2.7.20. "Rear fog lamp" means a lamp used to make the vehicle more easily visible from the rear in dense fog;

- 2.7.21. "Reversing lamp" means the lamp used to illuminate the road to the rear of the vehicle and to warn other road-users that the vehicle is reversing or about to reverse;
- 2.7.22. "Parking lamp" means a lamp which is used to draw attention to the presence of a stationary vehicle in a built-up area. In such circumstances it replaces the front and rear position lamps;
- 2.7.23. "End-outline marker lamp" means the lamp fitted near to the extreme outer edge and as close as possible to the top of the vehicle and intended to indicate clearly the vehicle's overall width. This lamp is intended, for certain vehicles and trailers, to complement the vehicle's front and rear position lamps by drawing particular attention to its bulk;
- 2.7.24. "Side marker lamp" means a lamp used to indicate the presence of the vehicle when viewed from the side;
- 2.7.25. "Daytime running lamp" means a lamp facing in a forward direction used to make the vehicle more easily visible when driving during daytime.^{2/}
- 2.7.26. "Cornering lamp" means a lamp used to provide supplementary illumination of that part of the road which is located near the forward corner of the vehicle at the side towards which the vehicle is going to turn.
- 2.7.27. "objective luminous flux" means a design value of the luminous flux of a replaceable light source. It shall be achieved, within the specified tolerances, when the replaceable light source is energized by the power supply at the specified test voltage, as indicated in the data sheet of the light source."
- 2.8. "Light emitting surface" of a "lighting device", "light-signalling device" or a retro-reflector means all or part of the exterior surface of the transparent material as declared in the request for approval by the manufacturer of the device on the drawing, see Annex 3;
- 2.9. "Illuminating surface" (see Annex 3);
- 2.9.1. "Illuminating surface of a lighting device" (paragraphs 2.7.9., to 2.7.10., 2.7.19, 2.7.21 and 2.7.26) means the orthogonal projection of the full aperture of the reflector, or in the case of headlamps with an ellipsoidal reflector of the "projection lens", on a transverse plane. If the lighting device has no reflector, the definition of paragraph 2.9.2. shall be applied. If the light emitting surface of the lamp extends over part only of the full aperture of the reflector, then the projection of that part only is taken into account.

^{2/} National requirements may permit the use of other devices to meet this function.

In the case of a dipped-beam headlamp, the illuminating surface is limited by the apparent trace of the cut-off on to the lens. If the reflector and lens are adjustable relative to one another, the mean adjustment should be used;

- 2.9.2. "Illuminating surface of a light-signalling device other than a retro-reflector" (paragraphs 2.7.11. to 2.7.15., 2.7.18., 2.7.20. and 2.7.22. to 2.7.25) means the orthogonal projection of the lamp in a plane perpendicular to its axis of reference and in contact with the exterior light-emitting surface of the lamp, this projection being bounded by the edges of screens situated in this plane, each allowing only 98 per cent of the total luminous intensity of the light to persist in the direction of the axis of reference.

To determine the lower, upper and lateral limits of the illuminating surface only screens with horizontal or vertical edges shall be used to verify the distance to the extreme edges of the vehicle and the height above the ground.

For other applications of the illuminating surface, e.g. distance between two lamps or functions, the shape of the periphery of this illuminating surface shall be used. The screens shall remain parallel, but other orientations are allowed to be used.

In the case of a light signalling device whose illuminating surface encloses either totally or partially the illuminating surface of another function or encloses a non-lighted surface, the illuminating surface may be considered to be the light emitting surface itself.

- 2.9.3 "Illuminating surface of a retro-reflector" (paragraph 2.7.16.) means, as declared by the applicant during the component approval procedure for the retro-reflectors, the orthogonal projection of a retro-reflector in a plane perpendicular to its axis of reference and delimited by planes contiguous to the declared outermost parts of the retro-reflectors= optical system and parallel to that axis. For the purposes of determining the lower, upper and lateral edges of the device, only horizontal and vertical planes shall be considered.

- 2.10. The "apparent surface" for a defined direction of observation means, at the request of the manufacturer or his duly accredited representative, the orthogonal projection of:

either the boundary of the illuminating surface projected on the exterior surface of the lens (a-b),

or the light-emitting surface (c-d),

in a plane perpendicular to the direction of observation and tangential to the most exterior point of the lens (see Annex 3 to this Regulation).

- 2.11. "Axis of reference" (or "reference axis") means the characteristic axis of the lamp determined by the manufacturer (of the lamp) for use as the direction of reference ($H = 0^\circ$, $V = 0^\circ$) for angles of field for photometric measurements and for installing the lamp on the vehicle;
- 2.12. "Centre of reference" means the intersection of the axis of reference with the exterior light-emitting surface; it is specified by the manufacturer of the lamp;
- 2.13. "Angles of geometric visibility" means the angles which determine the field of the minimum solid angle in which the apparent surface of the lamp must be visible. That field of the solid angle is determined by the segments of the sphere of which the centre coincides with the centre of reference of the lamp and the equator is parallel with the ground. These segments are determined in relation to the axis of reference. The horizontal angles β correspond to the longitude and the vertical angles α to the latitude. There must be no obstacle on the inside of the angles of geometric visibility to the propagation of light from any part of the apparent surface of the lamp observed from infinity.

If measurements are taken closer to the lamp, the direction of observation must be shifted parallel to achieve the same accuracy.

On the inside of the angles of geometric visibility no account is taken of obstacles, if they were already presented when the lamp was type-approved.

If, when the lamp is installed, any part of the apparent surface of the lamp is hidden by any further parts of the vehicle, proof shall be furnished that the part of the lamp not hidden by obstacles still conforms to the photometric values prescribed for the approval of the device as an optical unit (see Annex 3 of this Regulation). Nevertheless, when the vertical angle of geometric visibility below the horizontal may be reduced to 5° (lamp at less than 750 mm above the ground) the photometric field of measurements of the installed optical unit may be reduced to 5° below the horizontal.

- 2.14. "Extreme outer edge" on either side of the vehicle, means the plane parallel to the median longitudinal plane of the vehicle and touching its lateral outer edge, disregarding the projection:
- 2.14.1. of tyres near their point of contact with the ground, and of connections for tyre-pressure gauges;
- 2.14.2. of any anti-skid devices mounted on the wheels;
- 2.14.3. of rear-view mirrors;
- 2.14.4. of side direction-indicator lamps, end-outline marker lamps, front and rear position lamps, parking lamps, retro-reflectors and side-marker lamps;

2.14.5. of customs seals affixed to the vehicle, and of devices for securing and protecting such seals.

2.15. "Overall width" means the distance between the two vertical planes defined in paragraph 2.14. above;

2.16. The following shall be deemed to be:

2.16.1. "A single lamp" means a device or part of a device, having one function and one apparent surface in the direction of the reference axis (see paragraph 2.10. of this Regulation) and one or more light sources.

For the purpose of installation on a vehicle, a "single lamp" also means any assembly of two independent or grouped lamps, whether identical or not, having the same function, if they are installed so that the projection of their apparent surfaces in the direction of the reference axis occupies not less than 60 per cent of the smallest rectangle circumscribing the projections of the said apparent surfaces in the direction of the reference axis.

In such a case, each of these lamps shall, where approval is required, be approved as a type "D" lamp.

This possible combination does not apply to main-beam headlamps, dipped-beam headlamps, front fog lamps and cornering lamps.

2.16.2. "Two lamps" or "an even number of lamps", means a single light-emitting surface in the shape of a band or strip if such band or strip is placed symmetrically in relation to the median longitudinal plane of the vehicle, extends on both sides to within at least 0.4 m of the extreme outer edge of the vehicle, and is not less than 0.8 m long; the illumination of such surface shall be provided by not less than two light sources placed as close as possible to its ends; the light-emitting surface may be constituted by a number of juxtaposed elements on condition that the projections of the several individual light-emitting surfaces on a transverse plane occupy not less than 60 per cent of the area of the smallest rectangle circumscribing the projections of the said individual light-emitting surfaces;

2.17. "Distance between two lamps" which face in the same direction means the shortest distance between the two apparent surfaces in the direction of the reference axis. Where the distance between the lamps clearly meets the requirements of the Regulation, the exact edges of apparent surfaces need not be determined.

2.18. "Operating tell-tale" means a visual or auditory signal (or any equivalent signal) indicating that a device has been switched on and is operating correctly or not;

- 2.19. "Closed-circuit tell-tale" means a visual (or any equivalent signal) indicating that a device has been switched on, but not indicating whether it is operating correctly or not;
- 2.20. "Optional lamp" means a lamp, the installation of which is left to the discretion of the manufacturer;
- 2.21. "Ground" means the surface on which the vehicle stands which should be substantially horizontal;
- 2.22. "Movable components" of the vehicle mean those body panels or other vehicle parts the position(s) of which can be changed by tilting, rotating or sliding without the use of tools. They do not include tiltable driver cabs of trucks;
- 2.23. "Normal position of use of a movable component" means the position(s) of a movable component specified by the vehicle manufacturer for the normal condition of use and the park condition of the vehicle;
- 2.24. "Normal condition of use of a vehicle" means:
- 2.24.1. for a motor vehicle, when the vehicle is ready to move with its propulsion engine running and its movable components in the normal position(s) as defined in paragraph 2.23.;
- 2.24.2. and for a trailer, when the trailer is connected to a drawing motor vehicle in the conditions as prescribed in paragraph 2.24.1. and its movable components are in the normal position(s) as defined in paragraph 2.23.
- 2.25. "Park condition of a vehicle" means:
- 2.25.1. for a motor vehicle, when the vehicle is at standstill and its propulsion engine is not running and its movable components are in the normal position(s) as defined in paragraph 2.23:
- 2.25.2. and for a trailer, when the trailer is connected to a drawing motor vehicle in the condition as described in paragraph 2.25.1. and its movable components are in the normal position(s) as defined in paragraph 2.23.
- 2.26. "Bend lighting" means a lighting function to provide enhanced illumination in bends.
3. APPLICATION FOR APPROVAL
- 3.1. The application for approval of a vehicle type with regard to the installation of its lighting and light-signalling devices shall be submitted by the manufacturer or his duly accredited representative.

- 3.2. It shall be accompanied by the following documents and particulars in triplicate:
- 3.2.1. a description of the vehicle type with regard to the items mentioned in paragraphs 2.2.1. to 2.2.4. above, together with the restrictions on loading, particularly the maximum permissible load in the boot;
- 3.2.2. a list of the devices prescribed by the manufacturer for the lighting and light-signalling assembly. The list may include several types of device for each operation. Each type must be duly identified (component, type-approval mark, name of manufacturer, etc.), in addition the list may include in respect of each function the additional annotation "or equivalent devices";
- 3.2.3. a layout drawing of the lighting and light-signalling equipment as a whole, showing the position of the various devices on the vehicle;
- 3.2.4. if necessary, in order to verify the conformity to the prescriptions of the present Regulation, layout drawing(s) for each individual lamp showing the illuminating surface as defined in paragraph 2.9., the light-emitting surface as defined in paragraph 2.8., the axis of reference as defined in paragraph 2.11. and the centre of reference as defined in paragraph 2.12. This information is not necessary in the case of the rear registration plate lamp (paragraph 2.7.13.);
- 3.2.5. the application shall include a statement of the method used for the definition of the apparent surface (see paragraph 2.10.).
- 3.3. An unladen vehicle fitted with a complete set of lighting and light-signalling equipment, as prescribed in paragraph 3.2.2. above, and representative of the vehicle type to be approved shall be submitted to the technical service responsible for conducting approval tests.
- 3.4. The document provided in Annex 1 of this Regulation shall be attached to the type-approval documentation.
4. APPROVAL
- 4.1. If the vehicle type submitted for approval pursuant to this Regulation meets the requirements of the Regulation in respect of all the devices specified in the list, approval of that vehicle type shall be granted.
- 4.2. An approval number shall be assigned to each type approved. Its first two digits (at present 02, corresponding to the 02 series of amendments) shall indicate the series of amendments incorporating the most recent major technical amendments made to the Regulation at the time of issue of the approval. The same Contracting Party shall not assign this number to another vehicle type or to the same vehicle type submitted with equipment not specified in the list referred to in paragraph 3.2.2. above, subject to the provisions of paragraph 7. of this Regulation.

- 4.3. Notice of approval or of extension or refusal of approval or production definitely discontinued of a vehicle type/part pursuant to this Regulation shall be communicated to the Parties to the 1958 Agreement applying this Regulation, by means of a form conforming to the model in Annex 1 to this Regulation.
- 4.4. There shall be affixed, conspicuously and in a readily accessible place specified on the approval form, to every vehicle conforming to a vehicle type approved under this Regulation, an international approval mark consisting of:
- 4.4.1. A circle surrounding the letter "E" followed by the distinguishing number of the country which has granted approval ^{1/};
- 4.4.2. The number of this Regulation, followed by the letter "R", a dash and the approval number to the right of the circle prescribed in paragraph 4.4.1.
- 4.5. If the vehicle conforms to a vehicle type approved, under one or more other Regulations annexed to the Agreement, in the country which has granted approval under this Regulation, the symbol prescribed in paragraph 4.4.1. need not be repeated, in such a case the Regulation and approval numbers and the additional symbols of all the Regulations under which approval has been granted in the country which has granted approval under this Regulation shall be placed in vertical columns to the right of the symbol prescribed in paragraph 4.4.1.
- 4.6. The approval mark shall be clearly legible and be indelible.
- 4.7. The approval mark shall be placed close to or on the vehicle data plate affixed by the manufacturer.
- 4.8. Annex 2 to this Regulation gives examples of arrangements of approval marks.

^{1/} 1 for Germany, 2 for France, 3 for Italy, 4 for the Netherlands, 5 for Sweden, 6 for Belgium, 7 for Hungary, 8 for the Czech Republic, 9 for Spain, 10 for Serbia and Montenegro, 11 for the United Kingdom, 12 for Austria, 13 for Luxembourg, 14 for Switzerland, 15 (vacant), 16 for Norway, 17 for Finland, 18 for Denmark, 19 for Romania, 20 for Poland, 21 for Portugal, 22 for the Russian Federation, 23 for Greece, 24 for Ireland, 25 for Croatia, 26 for Slovenia, 27 for Slovakia, 28 for Belarus, 29 for Estonia, 30 (vacant), 31 for Bosnia and Herzegovina, 32 for Latvia, 33 (vacant), 34 for Bulgaria, 35 (vacant), 36 for Lithuania, 37 for Turkey, 38 (vacant), 39 for Azerbaijan, 40 for The former Yugoslav Republic of Macedonia, 41 (vacant), 42 for the European Community (Approvals are granted by its Member States using their respective ECE symbol), 43 for Japan, 44 (vacant), 45 for Australia, 46 for Ukraine, 47 for South Africa, 48 for New Zealand, 49 for Cyprus and 50 for Malta. Subsequent numbers shall be assigned to other countries in the chronological order in which they ratify or accede to the Agreement Concerning the Adoption of Uniform Technical Prescriptions for Wheeled Vehicles, Equipment and Parts which can be Fitted and/or be Used on Wheeled Vehicles and the Conditions for Reciprocal Recognition of Approvals Granted on the Basis of these Prescriptions, and the numbers thus assigned shall be communicated by the Secretary-General of the United Nations to the Contracting Parties to the Agreement.

5. GENERAL SPECIFICATIONS

- 5.1. The lighting and light-signalling devices shall be so fitted that under normal conditions of use as defined in paragraphs 2.24., 2.24.1. and 2.24.2. and notwithstanding any vibrations to which they may be subjected, they retain the characteristics prescribed by this Regulation and enable the vehicle to comply with the requirements of this Regulation. In particular, it shall not be possible for the lamps to be inadvertently maladjusted.
- 5.2. The illuminating lamps described in paragraphs 2.7.9., 2.7.10. and 2.7.19. shall be so installed that correct adjustment of their orientation can easily be carried out.
- 5.3. For all light-signalling devices, including those mounted on the side panels, the reference axis of the lamp when fitted to the vehicle must be parallel to the bearing plane of the vehicle on the road; in addition it must be perpendicular to the median longitudinal plane of the vehicle in the case of side retro-reflectors and of side-marker lamps and parallel to that plane in the case of all other signalling devices. In each direction a tolerance of $\sqrt{3}^\circ$ shall be allowed. In addition, any specific instructions as regards fitting laid down by the manufacturer must be complied with.
- 5.4. In the absence of specific instructions, the height and orientation of the lamps shall be verified with the vehicle unladen and placed on a flat, horizontal surface in the condition defined in paragraphs 2.24., 2.24.1. and 2.24.2.
- 5.5. In the absence of specific instructions lamps constituting a pair shall:
- 5.5.1. be fitted to the vehicle symmetrically in relation to the median longitudinal plane (this estimate to be based on the exterior geometrical form of the lamp and not on the edge of its illuminating surface referred to in paragraph 2.9.);
- 5.5.2. be symmetrical to one another in relation to the median longitudinal plane, this requirement is not valid with regard to the interior structure of the lamp;
- 5.5.3. satisfy the same colorimetric requirements; and 5.5.4. have substantially identical photometric characteristics.
- 5.6. On vehicles whose external shape is asymmetrical the above requirements shall be satisfied so far as is possible.
- 5.7. Lamps may be grouped, combined or reciprocally incorporated with one another provided that all requirements regarding colour, position, orientation, geometric visibility, electrical connections and other requirements, if any, for each lamp, are fulfilled.

- 5.8. The maximum height above the ground shall be measured from the highest point and the minimum height from the lowest point of the apparent surface in the direction of the reference axis.

In the case of dipped-beam headlamp, the minimum height in relation to the ground is measured from the lowest point of the effective outlet of the optical system (e.g. reflector, lens, projection lens) independent of its utilization.

Where the (maximum and minimum) height above the ground clearly meets the requirements of the Regulation, the exact edges of any surface need not be determined.

The position, as regards width, will be determined from that edge of the apparent surface in the direction of the reference axis which is the furthest from the median longitudinal plane of the vehicle when referred to the overall width, and from the inner edges of the apparent surface in the direction of the reference axis when referred to the distance between lamps.

Where the position, as regards width, clearly meets the requirements of the Regulation, the exact edges of any surface need not be determined.

- 5.9. In the absence of specific instructions, no lamps other than direction-indicator lamps, the vehicle-hazard warning signal and amber side-marker lamps complying with paragraph 6.18.7. below, shall be flashing lamps.
- 5.10. No red light which could give rise to confusion shall be emitted from a lamp as defined in paragraph 2.7. in a forward direction and no white light which could give rise to confusion, other than from the reversing lamp, shall be emitted from a lamp as defined in paragraph 2.7. in a rearward direction. No account shall be taken of lighting devices fitted for the interior lighting of the vehicle. In case of doubt, this requirement shall be verified as follows:
- 5.10.1. For the visibility of red light towards the front, there must be no direct visibility of the light-emitting surface of a red lamp if viewed by an observer moving within Zone 1 in a transverse plane situated 25 m in front of the vehicle (see Annex4);
- 5.10.2. For the visibility of white light towards the rear, there must be no direct visibility of a light-emitting surface of a white lamp if viewed by an observer moving within Zone 2 in a transverse plane situated 25 m behind the vehicle (see Annex4);
- 5.10.3. In their respective planes, the zones 1 and 2 explored by the eye of the observer are bounded;
- 5.10.3.1. in height, by two horizontal planes 1 m and 2.2 m respectively above the ground,

- 5.10.3.2. in width, by two vertical planes which, forming to the front and to the rear respectively an angle of 15° outwards from the vehicle's median longitudinal plane, pass through the point or points of contact of vertical planes parallel to the vehicle's median longitudinal plane delimiting the vehicle's overall width; if there are several points of contact, the foremost shall correspond to the forward plane and the rearmost to the rearward plane.
- 5.11. The electrical connections must be such that the front and rear position lamps, the end-outline marker lamps, if they exist, the side-marker lamps, if they exist, and the rear registration plate lamp can only be switched on and off simultaneously. This condition does not apply when using front and rear position lamps, as well as side-marker lamps when combined or reciprocally incorporated with said lamps, as parking lamps and when side-marker lamps are permitted to flash.
- 5.12. The electrical connections must be such that the main-beam and dipped-beam headlamps and the front fog lamps cannot be switched on unless the lamps referred to in paragraph 5.11. are also switched on. This requirement shall not apply, however, to main-beam or dipped-beam headlamps when their luminous warnings consist of the intermittent lighting up at short intervals of the main-beam headlamp or the intermittent lighting up at short intervals of the dipped-beam headlamp or the alternate lighting up at short intervals of the main-beam and dipped beam headlamps.
- 5.13. Tell-tale
- Where a closed-circuit tell-tale is prescribed by this Regulation it may be replaced by an "operating" tell-tale.
- 5.14. Concealable lamps
- 5.14.1. The concealment of lamps shall be prohibited, with the exception of the main-beam headlamps, the dipped-beam headlamps and the front fog lamps, which may be concealed when they are not in use.
- 5.14.2. In the event of any failure affecting the operation of the concealment device(s) the lamps shall remain in the position of use, if already in use, or shall be capable of being moved into the position of use without the aid of tools.
- 5.14.3. It must be possible to move the lamps into the position of use and to switch them on by means of a single control, without excluding the possibility of moving them into the position of use without switching them on. However, in the case of grouped main-beam and dipped-beam headlamps, the control referred to above is required only to activate the dipped-beam headlamps.
- 5.14.4. It must not be possible deliberately, from the driver's seat, to stop the movement of switched-on lamps before they reach the position of use. If there is a danger of

dazzling other road users by the movement of the lamps, they may light up only when they have reached their position of use.

5.14.5. When the concealment device has a temperature of -30°C to $+50^{\circ}\text{C}$ the headlamps must be capable of reaching the position of use within three seconds of initial operation of the control.

5.15. The colours of the light emitted by the lamps are the following:

main-beam headlamp:	white
dipped-beam headlamp:	white
front fog lamp:	white or yellow
reversing lamp:	white
direction-indicator lamp:	amber
hazard warning signal:	amber
stop lamp:	red
rear registration plate lamp:	white
front position lamp:	white
rear position lamp:	red
rear fog lamp:	red
parking lamp:	white in front, red at the rear, amber if reciprocally incorporated in the side direction-indicator lamps or in the side-marker lamps.
side-marker lamp:	amber; however the rearmost side-marker lamp can be red if it is grouped or combined or reciprocally incorporated with the rear position lamp, the rear end-outline marker lamp, the rear fog lamp, the stop lamp or is grouped or has part of the light emitting surface in common with the rear retro-reflector.
end-outline marker lamp:	white in front, red at the rear
daytime running lamp:	white
rear retro-reflector, non- triangular:	red
rear retro-reflector, triangular:	red
front retro-reflector, non- triangular:	identical to incident light <u>4/</u>
side retro-reflector, non- triangular:	amber; however the rearmost side retro-reflector can be red if it is grouped or

4/ Also known as white or colourless retro-reflector

has part of the light emitting surface in common with the rear position lamp, the rear end-outline marker lamp, the rear fog lamp, the stop-lamp or the red rearmost side-marker lamp.

cornering lamp:

white

retro-reflective marking:

white or yellow to the side;

red to the rear.^{5/}

5.16. Number of lamps

5.16.1. The number of lamps mounted on the vehicle should be equal to the number(s) specified in each of paragraphs 6.1. to 6.19.

5.17. Except as provided by paragraphs 5.18., 5.19. and 5.21., lamps may be installed on movable components.

5.18. Rear position lamps, rear direction-indicators and rear retro- reflectors, triangular as well as non triangular, must not be installed on movable components unless at all fixed positions of the movable components the lamps on the movable components meet all the position, geometric visibility and photometric requirements for those lamps.

Should the above functions be obtained by an assembly of two lamps marked "D" (see paragraph 2.16.1.) only one of these lamps needs to meet the above-mentioned requirements.

5.19. There must not be any movable component, with or without a light-signalling device installed on it, which in any fixed position hides more than 50 per cent of the apparent surface of front and rear position lamps, front and rear direction-indicator lamps and retro-reflectors when viewed in the reference axis of this specific device.

If this is not practicable:

5.19.1. a remark in the communication form (item 10.1. of Annex1) shall inform other Administrations that more than 50 per cent of the apparent surface in the direction of the reference axis can be hidden by the movable components;

5.19.2. in case of paragraph 5.19.1., a notice in the vehicle shall inform the user that in certain position(s) of the movable components other road users shall be warned of the presence of the vehicle on the road; for example by means of a warning triangle or other devices according to national requirements for use on the road.

^{5/} Nothing in this Regulation shall preclude the contracting Parties applying this Regulation from allowing the use of yellow line or contour markings to the rear in their territories.

- 5.20. When the movable components are in a position other than a "Normal position" as defined in paragraph 2.23., the devices installed on them shall not cause undue discomfort to road users.
- 5.21. When a lamp is installed on a movable component and the movable component is in the normal position(s) of use (see paragraph 2.23.), the lamp must always return to the position(s) specified by the manufacturer in accordance with this Regulation. In the case of dipped-beam headlamps and front fog lamps, this requirement shall be considered satisfied if, when the movable components are moved and returned to the normal position 10 times, no value of the angular inclination of these lamps, relative to its support, measured after each operation of the movable component, differs by more than 0.15 per cent from the average of the 10 measured values. If this value is exceeded each limit specified in paragraph 6.2.6.1.1. shall then be modified by this excess to decrease the allowed range of inclinations when checking the vehicle according to Annex 6.
- 5.22. With the exception of retro-reflectors, a lamp even bearing an approval mark is deemed not to be present when it cannot be made to operate by the sole installation of a light source.
- 5.23. Lamps shall be fitted in a vehicle in such a way that the light source can be correctly replaced according to the instructions of the vehicle manufacturer without the use of special tools, other than those provided with the vehicle by the manufacturer. This requirement is not applicable to:
- (a) devices approved with a non-replaceable light source;
 - (b) devices approved with light sources according to Regulation No. 99.
- 5.24. Any temporary fail-safe replacement of the light-signalling function of a rear position lamp is allowed, provided that the substituting function in case of a failure is similar in colour, main intensity and position to the function that has ceased to operate and provided that the substituting device remains operational in its original safety function. During substitution, a tell-tale on the dashboard (see para. 2.18. of this Regulation) shall indicate occurrence of a temporary replacement and need for repair.
6. INDIVIDUAL SPECIFICATIONS
- 6.1. MAIN-BEAM HEADLAMP
- 6.1.1. Presence
- Mandatory on motor vehicles. Prohibited on trailers.

6.1.2. Number

Two or four.

For vehicles of the category N₃:

Two extra main-beam headlamps may be installed.

Where a vehicle is fitted with four concealable headlamps the installation of two additional headlamps shall only be authorized for the purpose of light-signalling, consisting of intermittent illumination, at short intervals (see paragraph 5.12.) in daylight.

6.1.3. Arrangement

No individual specifications.

6.1.4. Position

6.1.4.1. In width: no individual specifications.

6.1.4.2. In height: no individual specifications.

6.1.4.3. In length: at the front of the vehicle and fitted in such a way that the light emitted does not cause discomfort to the driver either directly or indirectly through the rear-view mirrors and/or other reflecting surfaces of the vehicle.

6.1.5. Geometric visibility

The visibility of the illuminating surface, including its visibility in areas which do not appear to be illuminated in the direction of observation considered, must be ensured within a divergent space defined by generating lines based on the perimeter of the illuminating surface and forming an angle of not less than 5° with the axis of reference of the headlamp. The origin of the angles of geometric visibility is the perimeter of the projection of the illuminating surface on a transverse plane tangent to the foremost part of the lens of the headlamp.

6.1.6. Orientation

Towards the front.

Not more than one main-beam headlamp on each side of the vehicle may swivel to produce bend lighting.

6.1.7. Electrical connections

6.1.7.1. The main-beam headlamps may be switched on either simultaneously or in pairs. In case the extra two main-beam headlamps are installed, as permitted under paragraph 6.1.2. for vehicles of the category N₃ only, no more than two pairs may be simultaneously lit. For changing over from the dipped to the main beam all main-beam headlamps shall be switched off simultaneously.

6.1.7.2. The dipped-beams may remain switched on at the same time as the main beams.

6.1.7.3. Where four concealable headlamps are fitted their raised position must prevent the simultaneous operation of any additional headlamps fitted, if these are intended to provide light signals consisting of intermittent illumination at short intervals (see paragraph 5.12.) in daylight.

6.1.8. Tell-tale

Circuit-closed tell-tale mandatory.

6.1.9. Other requirements

6.1.9.1. The aggregate maximum intensity of the main-beam headlamps which can be switched on simultaneously shall not exceed 225,000 cd, which corresponds to a reference value of 75.

6.1.9.2. This maximum intensity shall be obtained by adding together the individual reference marks which are indicated on the several headlamps. The reference mark "10" shall be given to each of the headlamps marked "R" or "CR".

6.2. DIPPED-BEAM HEADLAMP

6.2.1. Presence

Mandatory on motor vehicles. Prohibited on trailers.

6.2.2. Number

Two.

6.2.3. Arrangement

No special requirement.

6.2.4. Position

6.2.4.1. In width: that edge of the apparent surface in the direction of the reference axis which is farthest from the vehicle's median longitudinal plane shall be not more than 400 mm from the extreme outer edge of the vehicle.

The inner edges of the apparent surfaces in the direction of the reference axes shall be not less than 600 mm apart. This does not apply, however, for M₁ and N₁ category vehicles; for all other categories of motor vehicles this distance may be reduced to 400 mm where the overall width of the vehicle is less than 1,300 mm.

6.2.4.2. In height: not less than 500 mm and not more than 1,200 mm above the ground. For category N₃G (off-road) vehicles 6/ the maximum height may be increased to 1,500 mm.

6.2.4.3. In length: at the front of the vehicle. This requirement shall be deemed to be satisfied if the light emitted does not cause discomfort to the driver either directly, or indirectly through the rear-view mirrors and/or other reflecting surfaces of the vehicle.

6.2.5. Geometric visibility

Defined by angles α and β as specified in paragraph 2.13.

α = 15° upwards and 10° downwards,

β = 45° outwards and 10° inwards.

Since the photometric values required for dipped-beam headlamps do not cover the full geometric field of vision, a minimum value of 1 cd in the space remaining is required for type- approval purposes. The presence of partitions or other items of equipment near the headlamp shall not give rise to secondary effects causing discomfort to other road users.

6.2.6. Orientation

Towards the front.

6.2.6.1. Vertical orientation

6.2.6.1.1. The initial downward inclination of the cut-off of the dipped-beam to be set in the unladen vehicle state with one person in the driver's seat shall be specified within an accuracy of 0.1 per cent by the manufacturer and indicated in a clearly legible

6/ As defined in the Consolidated Resolution on the Construction of Vehicles (R.E.3), Annex 7 (document TRANS/WP.29/78/Rev.1/Amend.2).

and indelible manner on each vehicle close to either headlamp or the manufacturer's plate by the symbol shown in Annex 7.

The value of this indicated downward inclination shall be defined in accordance with paragraph 6.2.6.1.2.

- 6.2.6.1.2. Depending on the mounting height in metres (h) of the lower edge of the apparent surface in the direction of the reference axis of the dipped-beam headlamp, measured on the unladen vehicles, the vertical inclination of the cut-off of the dipped-beam shall, under all the static conditions of Annex 5, remain between the following limits and the initial aiming shall have the following values:

$h < 0.8$

limits :	between -0.5 % and -2.5 %
initial aiming:	between -1.0 % and -1.5 %

$0.8 \leq h \leq 1.0$

limits :	between -0.5 % and -2.5 %
initial aiming:	between -1.0 % and -1.5 %

or, at the discretion of the manufacturer,

limits :	between -1.0 % and -3.0 %
initial aiming:	between -1.5 % and -2.0 %

The application for the vehicle type-approval shall, in this case, contain information as to which of the two alternatives is to be used.

$h > 1.0$

limits :	between -1.0 % and -3.0 %
initial aiming:	between -1.5 % and -2.0 %

The above limits and the initial aiming values are summarized in the diagram below.

For category N₃G (off-road) vehicles where the headlamps exceed a height of 1,200 mm, the limits for the vertical inclination of the cut-off shall be between: -1.5 % and -3.5 %.

The initial aim shall be set between: -2 % and -2.5 %.

- 6.2.6.2. Headlamp levelling device

6.2.6.2.1. In the case where a headlamp levelling device is necessary to satisfy the requirements of paragraphs 6.2.6.1.1. and 6.2.6.1.2., the device shall be automatic.

6.2.6.2.2. However, devices which are adjusted manually, either continuously or non-continuously, shall be permitted, provided they have a stop position at which the lamps can be returned to the initial inclination defined in paragraph 6.2.6.1.1. by means of the usual adjusting screws or similar means.

These manually adjustable devices must be operable from the driver's seat.

Continually adjustable devices must have reference marks indicating the loading conditions that require adjustment of the dipped-beam.

The number of positions on devices which are not continuously adjustable must be such as to ensure compliance with the range of values prescribed in paragraph 6.2.6.1.2. in all the loading conditions defined in Annex 5.

For these devices also, the loading conditions of Annex 5 that require adjustment of the dipped-beam shall be clearly marked near the control of the device (see Annex 8).

6.2.6.2.3. In the event of a failure of devices described in paragraphs 6.2.6.2.1. and 6.2.6.2.2., the dipped-beam shall not assume a position in which the dip is less than it was at the time when the failure of the device occurred.

6.2.6.3. Measuring procedure

6.2.6.3.1. After adjustment of the initial inclination, the vertical inclination of the dipped-beam, expressed in percent, shall be measured in static conditions under all the loading conditions defined in Annex 5.

6.2.6.3.2. The measurement of the variation of dipped-beam inclination as a function of load must be carried out in accordance with the test procedure set out in Annex 6.

6.2.6.4. Horizontal orientation

The horizontal orientation of one or both dipped-beam headlamps may be varied to produce bend lighting, provided that if the whole beam or the kink of the elbow of the cut-off is moved, the kink of the elbow of the cut-off shall not intersect the line of the trajectory of the centre of gravity of the vehicle at distances from the front of the vehicle which are larger than 100 times the mounting height of the respective dipped-beam headlamps.

6.2.7. Electrical connections

The control for changing over to the dipped-beam must switch off all main-beam headlamps simultaneously.

The dipped beam may remain switched on at the same time as the main beams.

In the case of dipped-beam headlamps according to Regulation No. 98, the gas-discharge light sources shall remain switched on during the main-beam operation.

One additional light source, located inside the dipped-beam headlamps or in a lamp (except the main-beam headlamp) grouped or reciprocally incorporated with the respective dipped-beam headlamps, may be activated to produce bend lighting, provided that the horizontal radius of curvature of the trajectory of the centre of gravity of the vehicle is 500 m or less. This may be demonstrated by the manufacturer by calculation or by other means accepted by the authority responsible for type approval.

Dipped-beam headlamps may be switched ON or OFF automatically. However, it shall be always possible to switch these dipped-beam headlamps ON and OFF manually.

6.2.8. Tell-tale

Tell-tale optional.

However, in the case where the whole beam or the kink of the elbow of the cut-off is moved to produce bend lighting, an operational tell-tale is mandatory; it shall be a flashing warning light which comes on in the event of a malfunction of the displacement of the kink of the elbow of the cut-off.

6.2.9. Other requirements

The requirements of paragraph 5.5.2. shall not apply to dipped-beam headlamps.

Dipped-beam headlamps with a light source having an objective luminous flux which exceeds 2,000 lumen shall only be installed in conjunction with the installation of headlamp cleaning device(s) according to Regulation No. 45. ^{7/} In addition, with respect to vertical inclination, the provisions of paragraph 6.2.6.2.2. above shall not be applied.

Only dipped-beam headlamps according to Regulations Nos. 98 or 112 may be used to produce bend lighting.

^{7/} Contracting Parties to the respective regulations can still prohibit the use of mechanical cleaning systems when headlamps with plastic lenses, marked "PL", are installed.

If bend lighting is produced by a horizontal movement of the whole beam or the kink of the elbow of the cut-off, it shall be activated only if the vehicle is in forward motion; this shall not apply if bend lighting is produced for a right turn in right hand traffic (left turn in left hand traffic).

6.3. FRONT FOG LAMP

6.3.1. Presence

Optional on motor vehicles. Prohibited on trailers.

6.3.2. Number

Two.

6.3.3. Arrangement

No special requirement.

6.3.4. Position

6.3.4.1. In width: that point on the apparent surface in the direction of the reference axis which is farthest from the vehicle's median longitudinal plane shall not be more than 400 mm from the extreme outer edge of the vehicle.

6.3.4.2.. In height:

minimum: Not less than 250 mm above the ground.

maximum: For M₁ and N₁ category vehicles not more than 800 mm above the ground; For all other categories of vehicles no maximum height.

However, no point on the apparent surface in the direction of the reference axis must be higher than the highest point on the apparent surface in the direction of the reference axis of the dipped-beam headlamp.

6.3.4.3. In length: at the front of the vehicle. This requirement shall be deemed to be satisfied if the light emitted does not cause discomfort to the driver either directly, or indirectly through the rear-view mirrors and/or other reflecting surfaces of the vehicle.

6.3.5. Geometric visibility

Defined by angles α and β as specified in paragraph 2.13,

$\alpha = 5^\circ$ upwards and downwards,

$\beta = 45^\circ$ outwards and 10° inwards.

6.3.6. Orientation

Towards the front.

The alignment of the front fog lamps must not vary according to the angle of lock of the steering.

They must be directed forward without causing undue dazzle or discomfort to oncoming drivers and other road users.

6.3.7. Electrical connections

It must be possible to switch the front fog lamps on and off independently of the main-beam headlamps, the dipped-beam headlamps or any combination of main- and dipped-beam headlamps.

6.3.8. Tell-tale

Circuit-closed tell-tale mandatory. An independent non-flashing warning light.

6.3.9. Other requirements

None.

6.4. REVERSING LAMP

6.4.1. Presence

Mandatory on motor vehicles and on trailers of categories O₂, O₃ and O₄. Optional on trailers of category O₁.

6.4.2. Number

6.4.2.1. One device mandatory and a second device optional on motor vehicles of category M₁ and on all other vehicles with a length not exceeding 6000 mm.

6.4.2.2. Two devices mandatory and two devices optional on all vehicles with a length exceeding 6,000 mm, except vehicles of category M₁.

6.4.3. Arrangement

No special requirement.

6.4.4. Position

6.4.4.1. In width: no special requirement.

6.4.4.2. In height: not less than 250 mm and not more than 1,200 mm above the ground.

6.4.4.3. In length: at the rear of the vehicle.

However, if installed, the two optional devices mentioned in paragraph 6.4.2.2. shall be fitted on the side or rear of the vehicle, in conformity with the requirements of paragraphs 6.4.5. and 6.4.6.

6.4.5. Geometric visibility

Defined by angles α and β , as specified in paragraph 2.13.;

α = 15° upwards and 5° downwards,

β = 45° to right and to left if there is only one device,
45° outwards and 30° inwards if there are two.

The reference axis of the two optional devices mentioned in paragraph 6.4.2.2., if fitted on the side of the vehicle shall be orientated sideward horizontally with an inclination of $10^\circ \pm 5^\circ$ in relation to the median longitudinal plane of the vehicle.

6.4.6. Orientation

Rearwards and sideward, as specified in paragraph 6.4.5. above.

All the reversing lamps fitted on the vehicle must not cause undue dazzle or discomfort to other road users.

6.4.7. Electrical connections

6.4.7.1. They shall be such that the lamp can light up only if the reverse gear is engaged and if the device which controls the starting and stopping of the engine is in such a position that operation of the engine is possible. It shall not light up or remain lit if either of the above conditions is not satisfied.

6.4.7.2. Moreover, the electrical connections of the two optional devices mentioned in paragraph 6.4.2.2. shall be such that these devices cannot light up unless the lamps referred to in paragraph 5.11. are switched on.

6.4.8. Tell-tale

Tell-tale optional.

6.4.9. Other requirements

None.

6.5. DIRECTION-INDICATOR LAMP

6.5.1. Presence (see figure below)

Mandatory. Types of direction-indicator lamps fall into categories (1, 1a, 1b, 2a, 2b, 5 and 6) the assembly of which on one vehicle constitutes an arrangement ('A' and 'B').

Arrangement 'A' shall apply to all motor vehicles.

Arrangement 'B' shall apply to trailers only.

6.5.2. Number

According to the arrangement.

6.5.3. Arrangements (see figure below)

A: Two front direction-indicator lamps of the following categories:

1 or 1a or 1b,

if the distance between the edge of the apparent surface in the direction of the reference axis of this lamp and that of the apparent surface in the direction of the reference axis of the dipped-beam headlamp and/or the front fog lamp, if there is one, is at least 40 mm;

1a or 1b,

if the distance between the edge of the apparent surface in the direction of the reference axis of this lamp and that of the apparent surface in the direction of the reference axis of the dipped-beam headlamp and/or the front fog lamp, if there is one, is greater than 20 mm and less than 40 mm;

1b,

if the distance between the edge of the apparent surface in the direction of the reference axis of this lamp and that of the apparent surface in the direction of the reference axis of the dipped-beam headlamp and/or the front fog lamp, if there is one, is less than or equal to 20 mm;

two rear direction-indicator lamps (category 2a or 2b);

two optional lamps (category 2a or 2b) on all vehicles in categories M₂, M₃, N₂, N₃.

two side direction-indicator lamps of the categories 5 or 6 (minimum requirements):

5
for all M1 vehicles;
for N1, M2 and M3 vehicles not exceeding 6 metres in length.

6
for all N2 and N3 vehicles;
for N1, M2 and M3 vehicles exceeding 6 metres in length.

It is permitted to replace category 5 side direction-indicator lamps by category 6 side direction-indicator lamps in all instances.

Where lamps combining the functions of front direction-indicator lamps (categories 1, 1a, 1b) and side direction-indicator lamps (categories 5 or 6) are fitted, two additional side direction-indicator lamps (categories 5 or 6) may be fitted to meet the visibility requirements of paragraph 6.5.5.

B: Two rear direction-indicator lamps (categories 2a or 2b).

two optional lamps (category 2a or 2b) on all vehicles in categories O₂, O₃ and O₄.

6.5.4. Position

6.5.4.1. In width: the edge of the apparent surface in the direction of the reference axis farthest from the median longitudinal plane of the vehicle must not be more than 400 mm from the extreme outer edge of the vehicle. This condition shall not apply to the optional rear lamps.

The distance between the inner edges of the two apparent surfaces in the direction of the reference axes shall not be less than 600 mm.

This distance may be reduced to 400 mm where the overall width of the vehicle is less than 1,300 mm.

6.5.4.2. In height: above the ground.

6.5.4.2.1 The height of the light-emitting surface of the side direction-indicator lamps of categories 5 or 6 must not be:

less than: 350 mm for M₁ and N₁ category of vehicles, and 500 mm for all other categories of vehicles, both measured from the lowest point; and

more than: 1,500 mm, measured from the highest point.

6.5.4.2.2. The height of the direction-indicator lamps of categories 1, 1a, 1b, 2a and 2b, measured in accordance with paragraph 5.8., shall not be less than 350 mm or more than 1,500 mm.

6.5.4.2.3. If the structure of the vehicle does not permit these upper limits, measured as specified above, to be respected, and if the optional lamps are not installed, they may be increased to 2,300 mm for side direction-indicator lamps of categories 5 and 6, and to 2,100 mm for the direction-indicator lamps of categories 1, 1a, 1b, 2a and 2b.

6.5.4.2.4. If optional lamps are installed, they shall be placed at a height compatible with the applicable requirements of paragraph 6.5.4.1., the symmetry of the lamps, and at a vertical distance as large as the shape of the bodywork makes it possible, but not less than 600 mm above the mandatory lamps.

6.5.4.3. In length (see figure below)

The distance between the light-emitting surface of the side direction-indicator lamp (categories 5 and 6) and the transverse plane which marks the forward boundary of the vehicle's overall length, shall not exceed 1,800 mm. However, for M₁ and N₁ category vehicles, and for all other categories of vehicles if the structure of the vehicle makes it impossible to comply with the minimum angles of visibility, this distance may be increased to 2,500 mm.

6.5.5. Geometric visibility

6.5.5.1. Horizontal angles: (see figure below)

Vertical angles: 15° above and below the horizontal for direction-indicator lamps of categories 1, 1a, 1b, 2a, 2b and 5. The vertical angle below the horizontal may be reduced to 5° if the lamps are less than 750 mm above the ground; 30° above and 5° below the horizontal for direction-indicator lamps of category 6. The vertical angle above the horizontal may be reduced to 5° if the optional lamps are not less than 2,100 mm above the ground.

FIGURE (see paragraph 6.5.)

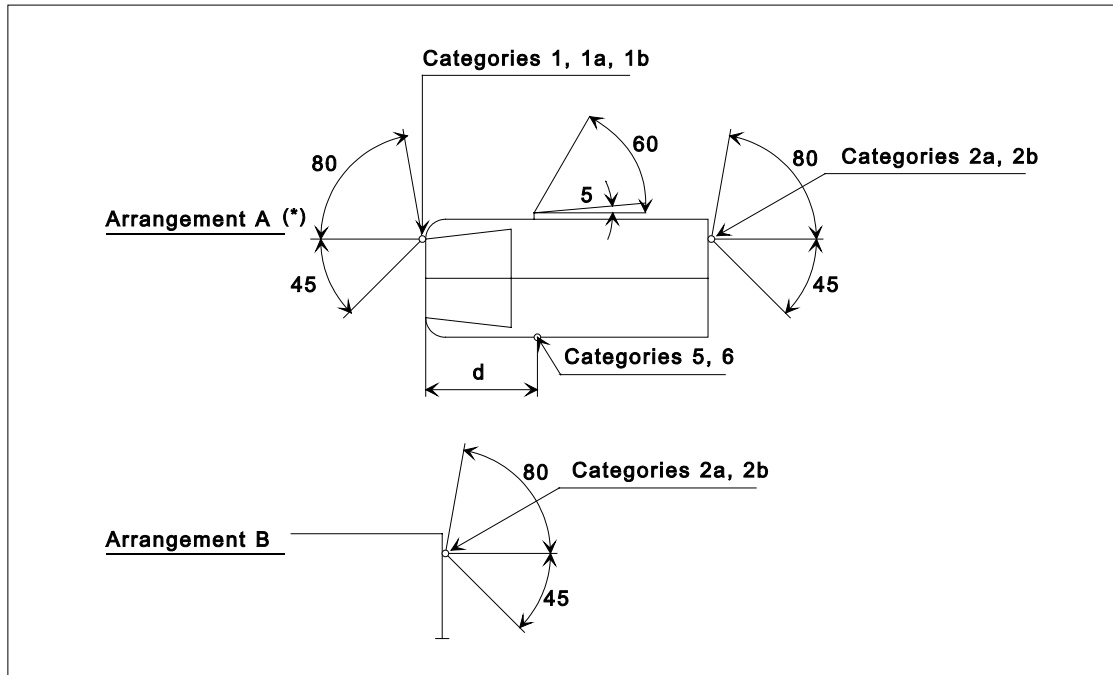

(*) The value of 5° given for dead angle of visibility to the rear of the side direction-indicator is an upper limit. $d \leq 1.80$ m (for M_1 and N_1 category vehicles $d \leq 2.50$ m).

6.5.5.2. or, at the discretion of the manufacturer, for M₁ and N₁ category vehicles **/:

Front and rear direction-indicator lamps, as well as side-marker lamps

Horizontal angles see figure below:

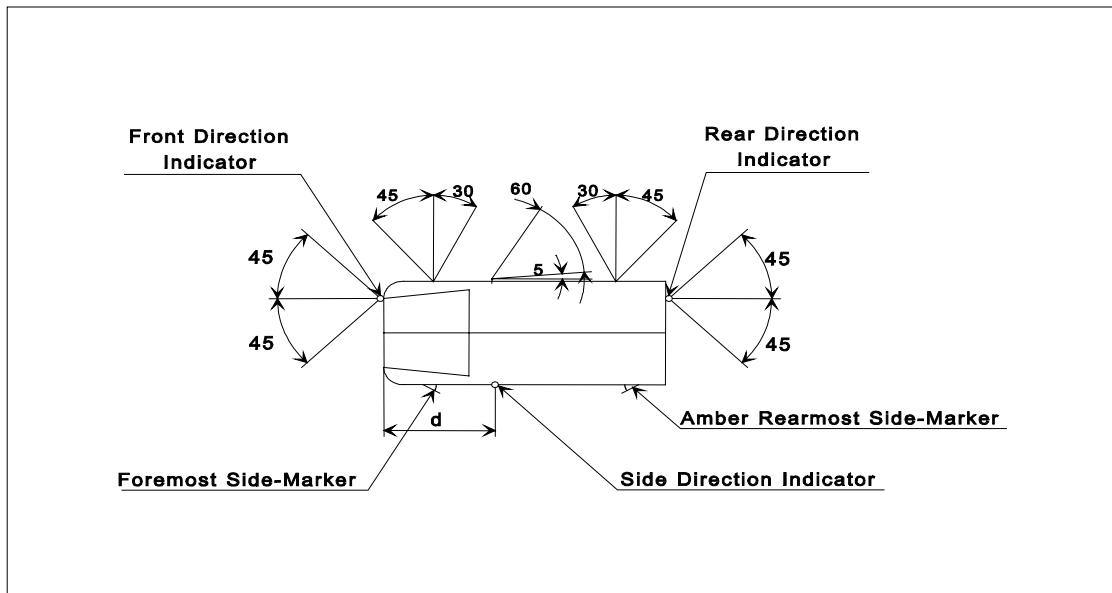

Vertical angles: 15° above and below the horizontal. The vertical angle below the horizontal may be reduced to 5° if the lamps are less than 750 mm above the ground.

To be considered visible, the lamp must provide an unobstructed view of the apparent surface of at least 12.5 square centimetres, except for side direction-indicators of categories 5 and 6. The illuminating surface area of any retro-reflector that does not transmit light shall be excluded.

**/ The value of 5° given for the dead angle of visibility to the rear of the side direction-indicator is an upper limit. $d \leq 2.50$ m

6.5.6. Orientation

According to the specifications for installation by the manufacturer, if any.

6.5.7. Electrical connections

Direction-indicator lamps shall switch on independently of the other lamps. All direction-indicator lamps on one side of a vehicle shall be switched on and off by means of one control and shall flash in phase.

On M₁ and N₁ vehicles less than 6 m in length, with an arrangement complying with paragraph 6.5.5.2. above, the amber side-marker lamps, when mounted, shall also flash at the same frequency (in phase) with the direction indicator lamps.

6.5.8. Tell-tale

Operating tell-tale mandatory for front and rear direction-indicator lamps. It may be visual or auditory or both. If it is visual it shall be a flashing light which, at least in the event of the malfunction of any of the front or rear direction-indicator lamps, is either extinguished, or remains alight without flashing, or shows a marked change of frequency. If it is entirely auditory it shall be clearly audible and shall show a marked change of frequency, at least in the event of the malfunction of any of the front or rear direction-indicator lamps.

If a motor vehicle is equipped to draw a trailer, it must be fitted with a special visual operational tell-tale for the direction-indicator lamps on the trailer unless the tell-tale of the drawing vehicle allows the failure of any one of the direction-indicator lamps on the vehicle combination thus formed to be detected.

For the optional pair of direction-indicator lamps on trailers, operating tell-tale shall not be mandatory.

6.5.9. Other requirements

The light shall be a flashing light flashing 90 ± 30 times per minute.

Operation of the light-signal control shall be followed within not more than one second by the emission of light and within not more than one and one-half seconds by its first extinction. If a motor vehicle is equipped to draw a trailer, the control of the direction-indicator lamps on the drawing vehicle shall also operate the indicator lamps of the trailer. In the event of failure, other than short-circuit, of one direction indicator lamp, the others must continue to flash, but the frequency in this condition may be different from that prescribed.

6.6. HAZARD WARNING SIGNAL

6.6.1. Presence

Mandatory.

The signal shall be given by simultaneous operation of the direction-indicator lamps in accordance with the requirements of paragraph 6.5. above.

6.6.2. Number

As specified in paragraph 6.5.2.

6.6.3. Arrangement

As specified in paragraph 6.5.3.

6.6.4. Position

6.6.4.1. Width

As specified in paragraph 6.5.4.1.

6.6.4.2. Height

As specified in paragraph 6.5.4.2.

6.6.4.3. Length

As specified in paragraph 6.5.4.3.

6.6.5. Geometric visibility

As specified in paragraph 6.5.5.

6.6.6. Orientation

As specified in paragraph 6.5.6.

6.6.7. Electrical connections

The signal shall be operated by means of a separate control enabling all the direction-indicator lamps to flash in phase.

On M₁ and N₁ vehicles less than 6 m in length, with an arrangement complying with paragraph 6.5.5.2. above, the amber side-marker lamps, when mounted, shall also flash at the same frequency (in phase) with the direction indicator lamps.

6.6.8. Tell-tale

Circuit-closed tell-tale mandatory. Flashing warning light, which can operate in conjunction with the tell-tale(s) specified in paragraph 6.5.8.

6.6.9. Other requirements

As specified in paragraph 6.5.9. If a power-driven vehicle is equipped to draw a trailer the hazard warning signal control shall also be capable of bringing the direction-indicator lamps on the trailer into action. The hazard warning signal shall be able to function even if the device which starts or stops the engine is in a position which makes it impossible to start the engine.

6.7. STOP LAMP

6.7.1. Presence

Devices of S1 or S2 categories : mandatory on all categories of vehicles.

Devices of S3 category : mandatory on M1 and N1 categories of vehicles, except for chassis-cabs and those N1 category vehicles with open cargo space; optional on other categories of vehicles"

6.7.2. Number

Two S1 or S2 category devices and one S3 category device on all categories of vehicles.

6.7.2.1. Except the case where category S3 device is installed, two optional category S1 or S2 devices may be installed on vehicles in categories M₂, M₃, N₂, N₃, O₂, O₃, and O₄.

6.7.2.2. Only, when the median longitudinal plane of the vehicle is not located on a fixed body panel but separates one or two movable parts of the vehicle (e.g. doors), and lacks sufficient space to install a single device of the S3 category on the median longitudinal plane above such movable parts, either:

two devices of the S3 category type "D" may be installed, or

one device of the S3 category may be installed offset to the left or to the right of the median longitudinal plane.

6.7.3. Arrangement

No special requirement.

6.7.4. Position

6.7.4.1. In width:

For M₁ and N₁ category vehicles: For S1 or S2 categories devices that point on the apparent surface in the direction of the reference axis which is farthest from the vehicle's median longitudinal plane shall not be more than 400 mm from the extreme outer edge of the vehicle;

for the distance in between the inner edges of the apparent surfaces in the direction of the reference axes there is no special requirement.

For all other categories of vehicles: For S1 or S2 categories devices the distance in between the inner edges of the apparent surfaces in the direction of the reference axes shall be not less than 600 mm. This distance may be reduced to 400 mm if the overall width of the vehicle is less than 1,300 mm.

For S3 category devices: the centre of reference shall be situated on the median longitudinal plane of the vehicle. However, in the case where the two devices of the S3 category are installed, according to paragraph 6.7.2., they shall be positioned as close as possible to the median longitudinal plane, one on each side of this plane.

In the case where one S3 category lamp offset from the median longitudinal plane is permitted according to paragraph 6.7.2., this offset shall not exceed 150 mm from the median longitudinal plane to the centre of reference of the lamp.

6.7.4.2. In height:

6.7.4.2.1. For S1 or S2 categories devices: above the ground, not less than 350 mm nor more than 1,500 mm (2,100 mm if the shape of the bodywork makes it impossible to keep within 1,500 mm and if the optional lamps are not installed. If the optional lamps are installed, they shall be positioned at a height compatible with the requirements of the width and the symmetry of the lamps, and at a vertical distance as large as the shape of the bodywork makes it possible, but not less than 600 mm above the mandatory lamps.)

6.7.4.2.2. For S3 category devices, the horizontal plane tangential to the lower edge of the apparent surface shall:

either not be more than 150 mm below the horizontal plane tangential to the lower edge of the exposed surface of the glass or glazing of the rear window, or

not be less than 850 mm above the ground.

However, the horizontal plane tangential to the lower edge of the apparent surface of S3 category device shall be above the horizontal plane tangential to the upper edge of the apparent surface of S1 or S2 categories devices.

6.7.4.3. In length:

For S1 or S2 categories devices : at the rear of the vehicle.

For S3 category devices : no special requirement.

6.7.5. Geometric visibility

Horizontal angle: For S1 or S2 categories devices:
45° to the left and to the right of the longitudinal axis
of the vehicle;

For S3 category devices: 10° to the left and to the
right of the longitudinal axis of the vehicle;

Vertical angle : For S1 or S2 categories devices: 15° above and
below the horizontal. However, the vertical angle
below the horizontal may be reduced to 5°, if the
height of the lamp is less than 750 mm. The vertical
angle above the horizontal may be reduced to 5° in
the case of optional lamps not less than 2,100 mm
above the ground;

For S3 category devices: 10° above and 5° below
the horizontal

6.7.6. Orientation

Towards the rear of the vehicle.

6.7.7. Electrical connections

Must light up when the service brake is applied. The stop lamps need not function if the device which starts and/or stops the engine is in a position which makes it impossible for the engine to operate.

The stop lamps may be activated by the application of a retarder or a similar device.

6.7.8. Tell-tale

Tell-tale optional; where fitted, this tell-tale must be an operating tell-tale consisting of a non-flashing warning light which comes on in the event of the malfunctioning of the stop lamps.

6.7.9. Other requirements

6.7.9.1. The S3 category device may not be reciprocally incorporated with any other lamp.

6.7.9.2. The S3 category device may be installed outside or inside the vehicle.

6.7.9.2.1. In the case where it is installed inside the vehicle:

the light emitted shall not cause discomfort to the driver through the rear-view mirrors and/or other surfaces of the vehicle (i.e. rear window);

6.8. REAR REGISTRATION PLATE LAMP

6.8.1. Presence

Mandatory.

6.8.2. Number

Such that the device illuminates the site of the registration plate.

6.8.3. Arrangement

Such that the device illuminates the site of the registration plate.

6.8.4. Position

6.8.4.1. In width: such that the device illuminates the site of the registration plate.

6.8.4.2. In height: such that the device illuminates the site of the registration plate.

6.8.4.3. In length: such that the device illuminates the site of the registration plate.

6.8.5. Geometric visibility

Such that the device illuminates the site of the registration plate.

6.8.6. Orientation

Such that the device illuminates the site of the registration plate.

6.8.7. Electrical connections

In accordance with paragraph 5.11.

6.8.8. Tell-tale

Tell-tale optional. If it exists, its function must be carried out by the tell-tale required for the front and rear position lamps.

6.8.9. Other requirements

When the rear registration plate lamp is combined with the rear position lamp, reciprocally incorporated in the stop lamp or in the rear fog lamp, the photometric characteristics of the rear registration plate lamp may be modified during the illumination of the stop lamp or the rear fog lamp.

6.9. FRONT POSITION LAMP

6.9.1. Presence

Mandatory on all motor vehicles.

Mandatory on trailers over 1,600 mm wide.

Optional on trailers which are not more than 1,600 mm wide.

6.9.2. Number

Two.

6.9.3. Arrangement

No special requirement.

6.9.4. Position

6.9.4.1. In width: that point on the apparent surface in the direction of the reference axis which is farthest from the vehicle's median longitudinal plane shall not be more than 400 mm from the extreme outer edge of the vehicle.

In the case of a trailer, that point on the apparent surface in the direction of the reference axis which is farthest from the median longitudinal plane shall not be more than 150 mm from the extreme outer edge of the vehicle.

The distance between the inner edges of the two apparent surfaces in the direction of the reference axes shall:

For M₁ and N₁ category vehicles: have no special requirement;

For all other categories of vehicles: be not less than 600 mm. This distance may be reduced to 400 mm where the overall width of the vehicle is less than 1,300 mm.

6.9.4.2. In height: above the ground, not less than 350 mm nor more than 1,500 mm (2,100 mm for O₁ and O₂ categories of vehicles, or if for any other categories of vehicles the shape of the bodywork makes it impossible to keep within 1,500 mm).

6.9.4.3. In length: no individual specification.

6.9.4.4. Where the front position lamp and another lamp are reciprocally incorporated, the apparent surface in the direction of the reference axis of the other lamp must be used to verify compliance with the positioning requirements (paragraphs 6.9.4.1. to 6.9.4.3.).

6.9.5. Geometric visibility

6.9.5.1. Horizontal angle for the two position lamps:
45° inwards and 80° outwards.

In the case of trailers, the angle inwards may be reduced to 5°.

Vertical angle:

15° above and below the horizontal. The vertical angle below the horizontal may be reduced to 5° in the case of lamps less than 750 mm above the ground.

6.9.5.2. For M₁ and N₁ category vehicles, as an alternative to paragraph 6.9.5.1., at the discretion of the manufacturer or his duly accredited representative, and only if a front side-marker lamp is installed on the vehicle.

Horizontal angle: 45° outwards to 45° inwards.

Vertical angle: 15° above and below the horizontal. The vertical angle below the horizontal may be reduced to 5° if the lamps are less than 750 mm above the ground.

To be considered visible, the lamp must provide an unobstructed view of the apparent surface of at least 12.5 square centimetres. The illuminating surface area of any retro-reflector that does not transmit light shall be excluded.

6.9.6. Orientation

Forwards.

6.9.7. Electrical connections

In accordance with paragraph 5.11.

6.9.8. Tell-tale

Circuit-closed tell-tale mandatory. This tell-tale shall be non-flashing and shall not be required if the instrument panel lighting can only be turned on simultaneously with the front position lamps.

6.9.9. Other requirements

None.

6.10. REAR POSITION LAMP

6.10.1. Presence

Mandatory.

6.10.2. Number

Two.

6.10.2.1. Except the case where end-outline marker lamps are installed, two optional position lamps may be installed on all vehicles in categories M₂, M₃, N₂, N₃, O₂, O₃, and O₄.

6.10.3. Arrangement

No special requirement.

6.10.4. Position

6.10.4.1. In width: that point on the apparent surface in the direction of the reference axis which is farthest from the vehicle's median longitudinal plane shall not be more than 400 mm from the extreme outer edge of the vehicle. This condition shall not apply to the optional rear lamps.

The distance between the inner edges of the two apparent surfaces in the direction of the reference axes shall:

For M₁ and N₁ category vehicles: have no special requirement;

For all other categories of vehicles: be not less than 600 mm. This distance may be reduced to 400 mm where the overall width of the vehicle is less than 1,300 mm.

6.10.4.2. In height: above the ground, not less than 350 mm nor more than 1,500 mm (2,100 mm if the shape of the bodywork makes it impossible to keep within 1,500 mm and if the optional lamps are not installed. If the optional lamps are installed,

they shall be placed at a height compatible with the applicable requirements of paragraph 6.10.4.1., the symmetry of the lamps, and at a vertical distance as large as the shape of the bodywork makes it possible, but not less than 600 mm above the mandatory lamps).

6.10.4.3. In length: at the rear of the vehicle.

6.10.5. Geometric visibility

6.10.5.1. Horizontal angle: 45° inwards and 80° outwards.

Vertical angle: 15° above and below the horizontal. The vertical angle below the horizontal may be reduced to 5° in the case of lamps less than 750 mm above the ground. The vertical angle above the horizontal may be reduced to 5° in the case of optional lamps not less than 2,100 mm above the ground.

6.10.5.2. For M₁ and N₁ category vehicles, as an alternative to paragraph 6.10.5.1., at the discretion of the manufacturer or his duly accredited representative, and only if a rear side-marker lamp is installed on the vehicle,

Horizontal angle: 45° outwards to 45° inwards.

Vertical angle: 15° above and below the horizontal. The vertical angle below the horizontal may be reduced to 5° if the lamps are less than 750 mm above the ground.

To be considered visible, the lamp must provide an unobstructed view of the apparent surface of at least 12.5 square centimetres. The illuminating surface area of any retro-reflector that does not transmit light shall be excluded.

6.10.6. Orientation

Rearwards.

6.10.7. Electrical connections

In accordance with paragraph 5.11.

6.10.8. Tell-tale

Circuit-closed tell-tale mandatory. It must be combined with that of the front position lamps.

6.10.9. Other requirements

None.

6.11. REAR FOG LAMP

6.11.1. Presence

Mandatory.

6.11.2. Number

One or two.

6.11.3 Arrangement

No special requirement.

6.11.4. Position

6.11.4.1. In width: if there is only one rear fog-lamp, it must be on the opposite side of the median longitudinal plane of the vehicle to the direction of traffic prescribed in the country of registration, the centre of reference may also be situated on the median longitudinal plane of the vehicle.

6.11.4.2. In height: not less than 250 mm nor more than 1,000 mm above the ground. For category N₃G (off-road) vehicles, the maximum height may be increased to 1,200 mm.

6.11.4.3. In length: at the rear of the vehicle.

6.11.5. Geometric visibility

Defined by angles α and β as specified in paragraph 2.13.

$\alpha = 5^\circ$ upwards and 5° downwards;

$\beta = 25^\circ$ to right and to left.

6.11.6. Orientation

Rearwards.

6.11.7. Electrical connections

These must be such that:

6.11.7.1. The rear fog-lamp(s) cannot be switched on unless the main beams, dipped beams or front fog-lamps are lit;

6.11.7.2. The rear fog-lamp(s) can be switched off independently of any other lamp;

- 6.11.7.3. Either of the following applies:
- 6.11.7.3.1. the rear fog lamp(s) may continue to operate until the position lamps are switched off, and the rear fog lamp(s) shall then remain off until deliberately switched on again;
- 6.11.7.3.2. a warning, at least audible, additional to the mandatory tell-tale (paragraph 6.11.8.) shall be given if the ignition is switched off or the ignition key is withdrawn and the driver's door is opened, whether the lamps in (paragraph 6.11.7.1.) are on or off, whilst the rear fog lamp switch is in the 'on' position.
- 6.11.7.4. Except as provided in paragraphs 6.11.7.1. and 6.11.7.3., the operation of the rear fog-lamp(s) shall not be affected by switching on or off any other lamps.
- 6.11.8. Tell-tale
Circuit-closed tell-tale mandatory. An independent non- flashing warning light.
- 6.11.9. Other requirements
In all cases, the distance between the rear fog-lamp and each stop-lamp must be greater than 100 mm.
- 6.12. PARKING LAMP
- 6.12.1. Presence
On motor vehicles not exceeding 6 m in length and not exceeding 2 m in width, optional.
On all other vehicles, prohibited.
- 6.12.2. Number
According to the arrangement.
- 6.12.3. Arrangement
Either two lamps at the front and two lamps at the rear, or one lamp on each side.
- 6.12.4. Position
6.12.4.1. In width: that point on the apparent surface in the direction of the reference axis which is farthest from the vehicle's median longitudinal plane shall not be more than 400 mm from the extreme outer edge of the vehicle.

Furthermore, if there are two lamps, they shall be on the sides of the vehicle.

6.12.4.2.

In height:

For M₁ and N₁ category vehicles: no special requirement;

For all other categories of vehicles: above the ground, not less than 350 mm nor more than 1,500 mm (2,100 mm if the shape of the bodywork makes it impossible to keep within 1,500 mm).

6.12.4.3.

In length: no special requirement.

6.12.5.

Geometric visibility

Horizontal angle: 45° outwards, forwards and rearwards.

Vertical angle: 15° above and below the horizontal. The vertical angle below the horizontal may be reduced to 5°, however, if the height of the lamp is less than 750 mm.

6.12.6.

Orientation

Such that the lamps meet the requirements for visibility forwards and rearwards.

6.12.7.

Electrical connections

The connection must allow the parking lamp(s) on the same side of the vehicle to be lit independently of any other lamps.

The parking lamp(s) must be able to function even if the device which starts and/or stops the engine is in a position which makes it impossible for the engine to operate.

6.12.8.

Tell-tale

Circuit-closed tell-tale optional. If there is one, it must not be possible to confuse it with the tell-tale for the front and rear position lamps.

6.12.9.

Other requirements

The functioning of this lamp may also be performed by simultaneously switching on the front and rear position lamps on the same side of the vehicle.

6.13. END-OUTLINE MARKER LAMP

6.13.1. Presence

Mandatory on vehicle exceeding 2.10 m in width. Optional on vehicles between 1.80 and 2.10 m in width. On chassis-cabs the rear end-outline marker lamps are optional.

6.13.2. Number

Two visible from the front and two visible from the rear.

6.13.3. Arrangement

No special requirement.

6.13.4 Position

6.13.4.1 In width:

Front and rear: as close as possible to the extreme outer edge of the vehicle. This condition is deemed to have been met when the point on the apparent surface in the direction of the reference axis which is farthest from the vehicle's median longitudinal plane is not more than 400 mm from the extreme outer edge of the vehicle.

6.13.4.2. In height:

Front: Motor vehicles - the horizontal plane tangential to the upper edge of the apparent surface in the direction of the reference axis of the device must not be lower than the horizontal plane tangential to the upper edge of the transparent zone of the wind-screen.

Trailers and semi-trailers - at the maximum height compatible with the requirements relating to the width, design and operational requirements of the vehicle and to the symmetry of the lamps.

Rear: At the maximum height compatible with the requirements relating to the width, design and operational requirements of the vehicle and to the symmetry of the lamps.

6.13.4.3. In length, no special requirement.

6.13.5. Geometric visibility

Horizontal angle: 80° outwards.

Vertical angle: 5° above and 20° below the horizontal.

6.13.6. Orientation

Such that the lamps meet the requirements for visibility forwards and rearwards.

6.13.7. Electrical connections

In accordance with paragraph 5.11.

6.13.8. Tell-tale

Tell-tale optional. If it exists, its function shall be carried out by the tell-tale required for the front and rear position lamps.

6.13.9. Other requirements

Provided that all other requirements are met, the lamp visible from the front and the lamp visible from the rear on the same side of the vehicle may be combined in one device.

The position of an end-outline marker lamp in relation to corresponding position lamp shall be such that the distance between the projections on a transverse vertical plane of the points nearest to one another on the apparent surfaces in the direction of the respective reference axes of the two lamps considered is not less than 200 mm.

6.14. REAR RETRO-REFLECTOR, NON-TRIANGULAR

6.14.1. Presence

Mandatory on motor vehicles.

Provided that they are grouped together with the other rear light-signalling devices, optional on trailers.

6.14.2. Number

Two, the performances of which shall conform to the requirements concerning Class IA or IB retro-reflectors in Regulation No 3. Additional retro-reflecting

devices and materials are permitted provided they do not impair the effectiveness of the mandatory lighting and light-signalling devices.

6.14.3 Arrangement

No special requirement.

6.14.4. Position

6.14.4.1. In width: that point on the illuminating surface which is farthest from the vehicle's median longitudinal plane shall not be more than 400 mm from the extreme outer edge of the vehicle.

The distance between the inner edges of the two apparent surfaces in the direction of the reference axes shall:

For M₁ and N₁ category vehicles: have no special requirement;

For all other categories of vehicles: be not less than 600 mm.

This distance may be reduced to 400 mm where the overall width of the vehicle is less than 1,300 mm.

6.14.4.2. In height: above the ground, not less than 250 mm nor more than 900 mm (1,500 mm if the shape of the bodywork makes it impossible to keep within 900 mm).

6.14.4.3. In length: at the rear of the vehicle.

6.14.5. Geometric visibility

Horizontal angle: 30° inwards and outwards.

Vertical angle: 10° above and below horizontal. The vertical angle below the horizontal may be reduced to 5° in the case of a retro-reflector less than 750 mm above the ground.

6.14.6. Orientation

Rearwards.

6.14.7. Other requirements

The illuminating surface of the retro-reflector may have parts in common with the apparent surface of any other lamp situated at the rear.

6.15. REAR RETRO-REFLECTOR, TRIANGULAR

6.15.1 Presence

Mandatory on trailers.

Prohibited on motor vehicles.

6.15.2. Number

Two, the performances of which shall conform to the requirements concerning Class IIIA retro-reflectors in Regulation No 3. Additional retro-reflecting devices and materials are permitted provided they do not impair the effectiveness of the mandatory lighting and light-signalling devices.

6.15.3. Arrangement

The apex of the triangle shall be directed upwards.

6.15.4. Position

6.15.4.1. In width: that point on the illuminating surface which is farthest from the vehicle's median longitudinal plane shall not be more than 400 mm from the extreme outer edge of the vehicle.

The inner edges of the retro-reflectors shall not be less than 600 mm apart. This distance may be reduced to 400 mm if the overall width of the vehicle is less than 1,300 mm.

6.15.4.2. In height: above the ground, not less than 250 mm nor more than 900 mm (1,500 mm if the shape of the bodywork makes it impossible to keep within 900 mm).

6.15.4.3. In length: at the rear of the vehicle.

6.15.5. Geometric visibility

Horizontal angle: 30° inwards and outwards.

Vertical angle: 15° above and below the horizontal. The vertical angle below the horizontal may be reduced to 5° in the case of a retro-reflector less than 750 mm above the ground.

6.15.6. Orientation

Rearwards.

6.15.7. Other requirements

No lamp shall be placed inside the triangle.

6.16. FRONT RETRO-REFLECTOR, NON-TRIANGULAR

6.16.1. Presence

Mandatory on trailers.

Mandatory on motor vehicles having all forward facing lamps with reflectors concealable.

Optional on other motor vehicles.

6.16.2. Number

Two, the performances of which shall conform to the requirements concerning Class IA or IB retro-reflectors in Regulation No 3. Additional retro-reflecting devices and materials are permitted provided they do not impair the effectiveness of the mandatory lighting and light-signalling devices.

6.16.3. Arrangement

No special requirement.

6.16.4. Position

6.16.4.1. In width: that point on the illuminating surface which is farthest from the vehicle's median longitudinal plane shall not be more than 400 mm from the extreme outer edge of the vehicle.

In the case of a trailer, the point of the illuminating surface which is farthest from the vehicle's median longitudinal plane shall not be farther than 150 mm from the extreme outer edge of the vehicle.

The distance between the inner edges of the two apparent surfaces in the direction of the reference axes shall:

For M₁ and N₁ category vehicles: have no special requirement;

For all other categories of vehicles: be not less than 600 mm. This distance may be reduced to 400 mm where the overall width of the vehicle is less than 1,300 mm.

6.16.4.2. In height: above the ground, not less than 250 mm nor more than 900 mm (1,500 mm if the shape of the bodywork makes it impossible to keep within 900 mm).

6.16.4.3. In length: at the front of the vehicle.

6.16.5. Geometric visibility

Horizontal angle, 30° inwards and outwards. In the case of trailers, the angle inwards may be reduced to 10°. If because of the construction of the trailers this angle cannot be met by the mandatory retro-reflectors, then additional (supplementary) retro-reflectors shall be fitted, without the width limitation (paragraph 6.16.4.1.), which shall, in conjunction with the mandatory retro-reflectors, give the necessary visibility angle.

Vertical angle: 10° above and below the horizontal. The vertical angle below the horizontal may be reduced to 5° in the case of a retro-reflector less than 750 mm above the ground.

6.16.6. Orientation

Towards the front.

6.16.7. Other requirements

The illuminating surface of the retro-reflector may have parts in common with the apparent surface of any other lamp situated at the front.

6.17. SIDE RETRO-REFLECTOR, NON-TRIANGULAR

6.17.1. Presence

Mandatory: On all motor vehicles the length of which exceeds 6 m.
On all trailers.

Optional: On motor vehicles the length of which does not exceed 6 m.

6.17.2. Number

Such that the requirements for longitudinal positioning are complied with. The performances of these devices shall conform to the requirements concerning Class IA or IB retro-reflectors in Regulation No 3. Additional retro-reflecting devices and materials are permitted provided they do not impair the effectiveness of the mandatory lighting and light-signalling devices.

6.17.3. Arrangement

No special requirement

6.17.4. Position

6.17.4.1. In width: no special requirement.

6.17.4.2. In height: above the ground, not less than 250 mm nor more than 900 mm (1,500 mm if the shape of the bodywork makes it impossible to keep within 900 mm).

6.17.4.3. In length: At least one side retro-reflector must be fitted to the middle third of the vehicle, the foremost side retro-reflector being not further than 3 m from the front; in the case of trailers, account shall be taken of the length of the drawbar for the measurement of this distance.

The distance between two adjacent side retro-reflectors shall not exceed 3 m. This does not, however, apply to M_1 and N_1 category vehicles.

If the structure of the vehicle makes it impossible to comply with such a requirement, this distance may be increased to 4 m. The distance between the rearmost side retro-reflector and the rear of the vehicle shall not exceed 1 m. However, for motor vehicles the length of which does not exceed 6 m, it is sufficient to have one side retro-reflector fitted within the first third and/or one within the last third of the vehicle length.

6.17.5. Geometric visibility

Horizontal angle: 45° to the front and to the rear.

Vertical angle: 10° above and below the horizontal. The vertical angle below the horizontal may be reduced to 5° in the case of a retro-reflector less than 750 mm above the ground.

6.17.6. Orientation

Towards the side.

6.17.7. Other requirements

The illuminating surface of the side retro-reflector may have parts in common with the apparent surface of any other side lamp.

6.18. SIDE-MARKER LAMPS

6.18.1. Presence

Mandatory: On all vehicles the length of which exceeds 6 m, except for chassis-cabs; the length of trailers shall be calculated including the drawbar.

The SM1 type of side-marker lamp shall be used on all categories of vehicles; however the SM2 type of side-marker lamps may be used on the M1 category of vehicles.

In addition, on M₁ and N₁ category vehicles less than 6 m in length, side-marker lamps shall be used, if they supplement the reduced geometric visibility requirements of front position lamps conforming to paragraph 6.9.5.2. and rear position lamps conforming to paragraph 6.10.5.2.

Optional:

On all other vehicles.

The SM1 or SM2 types of side-marker lamps may be used.

6.18.2. Minimum number per side

Such that the rules for longitudinal positioning are complied with.

6.18.3. Arrangement

No individual specifications.

6.18.4. Position

6.18.4.1. In width: no individual specifications.

6.18.4.2. In height: above the ground, not less than 250 mm nor more than 1,500 mm (2,100 mm if the shape of the bodywork makes it impossible to keep within 1,500 mm).

6.18.4.3. In length: at least one side-marker lamp must be fitted to the middle third of the vehicle, the foremost side-marker lamp being not further than 3 m from the front; in the case of trailers account shall be taken of the length of the drawbar for the measurement of this distance. The distance between two adjacent side-marker lamps shall not exceed 3 m. If the structure of the vehicle makes it impossible to comply with such a requirement, this distance may be increased to 4 m.

The distance between the rearmost side-marker lamp and the rear of the vehicle shall not exceed 1 m.

However, for vehicles the length of which does not exceed 6 m and for chassis-cabs, it is sufficient to have one side-marker lamp fitted within the first third and/or within the last third of the vehicle length.

6.18.5. Geometric visibility

Horizontal angle: 45° to the front and to the rear; however for vehicles on which the installation of the side-marker lamps is optional this value can be reduced to 30°.

If the vehicle is equipped with side-marker lamps used to supplement the reduced geometric visibility of front and rear direction indicator lamps conforming to paragraph 6.5.5.2. and/or position lamps conforming to paragraphs 6.9.5.2. and 6.10.5.2., the angles are 45° towards the front and rear ends of the vehicle and 30E towards the centre of the vehicle (see the figure in paragraph 6.5.5.2. above).

Vertical angle: 10° above and below the horizontal. The vertical angle below the horizontal may be reduced to 5° in the case of a side-marker lamp less than 750 mm above the ground.

6.18.6. Orientation

Towards the side.

6.18.7. Electrical connections

On M₁ and N₁ category vehicles less than 6 m in length amber side-marker lamps may be wired to flash, provided that this flashing is in phase and at the same frequency with the direction indicator lamps at the same side of the vehicle.
For all other categories of vehicles: no individual specification.

6.18.8. Tell-tale

Tell-tale optional. If it exists its function shall be carried out by the tell-tale required for the front and rear position lamps.

6.18.9. Other requirements

When the rearmost side-marker lamp is combined with the rear position lamp reciprocally incorporated with the rear fog-lamp or stop lamp, the photometric characteristics of the side-marker lamp may be modified during the illumination of the rear fog lamp or stop lamp.

Rear side-marker lamps must be amber if they flash with the rear direction indicator lamp.

6.19. DAYTIME RUNNING LAMP 8/

6.19.1. Presence

Optional on motor vehicles. Prohibited on trailers.

6.19.2. Number

Two.

6.19.3. Arrangement

No special requirement.

6.19.4. Position

6.19.4.1. In width: that point on the apparent surface in the direction of the reference axis which is farthest from the vehicle's median longitudinal plane shall not be more than 400 mm from the extreme outer edge of the vehicle.

The distance between the inner edges of the apparent surfaces in the direction of the reference axes shall not be less than 600 mm.

This distance may be reduced to 400 mm where the overall width of the vehicle is less than 1,300 mm.

6.19.4.2. In height: above the ground not less than 250 mm nor more than 1,500 mm.

6.19.4.3. In length: at the front of the vehicle. This requirement shall be deemed to be satisfied if the light emitted does not cause discomfort to the driver either directly, or indirectly through the rear-view mirrors and/or other reflecting surfaces of the vehicle.

6.19.5. Geometric visibility

Horizontal: outwards 20° and inwards 20°. Vertical : upwards 10° and downwards 10°.

6.19.6. Orientation

Towards the front.

6.19.7. Electrical connections

8/ The installation of this device may be forbidden on the basis of national regulations

If installed, the daytime running lamps shall be switched ON automatically when the device which starts and/or stops the engine is in a position which makes it possible for the engine to operate. It shall be possible to activate and deactivate the automatic switching ON of daytime running lamps without the use of tools.

The daytime running lamp shall switch OFF automatically when the headlamps are switched ON, except when the latter are used to give intermittent luminous warnings at short intervals.

6.19.8. Tell-tale

Closed-circuit tell-tale optional

6.19.7. Electrical connections

If installed, the daytime running lamps shall be switched ON automatically when the device which starts and/or stops the engine is in a position which makes it possible for the engine to operate. It shall be possible to activate and deactivate the automatic switching ON of daytime running lamps without the use of tools.

The daytime running lamp shall switch OFF automatically when the headlamps are switched ON, except when the latter are used to give intermittent luminous warnings at short intervals.

6.19.8. Tell-tale

Closed-circuit tell-tale optional.

6.20. CORNERING LAMP

6.20.1. Presence

Optional on motor vehicles.

6.20.2. Number

Two.

6.20.3. Arrangement

No special requirement.

6.20.4. Position

6.20.4.1. In width: that point on the apparent surface in the direction of the reference axis which is farthest from the vehicle's median longitudinal plane shall not be more than 400 mm from the extreme outer edge of the vehicle.

6.20.4.2. In length: not further than 1,000 mm from the front.

6.20.4.3. In height:

minimum: Not less than 250 mm above the ground.
maximum: Not more than 900 mm above the ground;

However, no point on the apparent surface in the direction of the reference axis shall be higher than the highest point on the apparent surface in the direction of the reference axis of the dipped-beam headlamp.

6.20.5. Geometric visibility

Defined by angles α and β as specified in paragraph 2.13.,

$\alpha = 10^\circ$ upwards and downwards,
 $\beta = 30^\circ$ to 60° outwards.

6.20.6. Orientation

Such that the lamps meet the requirements for geometric visibility.

6.20.7. Electrical connections

The cornering lamps must be so connected that they cannot be activated unless the main-beam headlamps or the dipped-beam headlamps are switched ON at the same time.

The cornering lamp on one side of the vehicle may only be switched ON automatically when the direction indicators on the same side of the vehicle are switched ON and/or when the steering angle is changed from the straight-ahead position towards the same side of the vehicle.

The cornering lamp shall be switched OFF automatically when the direction indicator is switched OFF and/or the steering angle has returned in the straight-ahead position.

6.20.8. Tell-tale

None

6.20.9. Other requirements

The cornering lamps shall not be activated at vehicle speeds above 40 km/h.

- 6.21. RETRO-REFLECTIVE MARKING BY MEANS OF SIDE AND REAR RETRO-REFLECTIVE LINES AND CONTOUR MARKINGS (Regulation No. 104)
- 6.21.1. Presence
- Prohibited on vehicles of category M₁.
Optional on vehicles of other categories (M₂, M₃, N₁, N₂, N₃, O₁, O₂, O₃ and O₄).
- 6.21.2. Arrangement
- 6.21.2.1. Retro-reflective marking materials installed on vehicles may be made up of an element or of several elements and must be mounted as close as possible to horizontally or vertically, compatible to the design and operation requirements of the vehicle.
- 6.21.2.2. The lower edge of the retro-reflective marking shall have a minimum height above the ground of at least 250 mm.
- 6.21.3. Position
- 6.21.3.1. The mounting of the markings should identify as close as possible the entire length and width (strips) or shape (contour markings) of the vehicle. "Entire" means at least 80 per cent of the length and/or width of a marked vehicle.
- 6.21.3.2. In case of non-continuous strips the distance between single elements should be as small as possible and should not exceed 50 per cent of the shortest element length.
7. MODIFICATIONS AND EXTENSION OF APPROVAL OF THE VEHICLE TYPE OR OF THE INSTALLATION OF ITS LIGHTING AND LIGHT-SIGNALLING DEVICES
- 7.1. Every modification of the vehicle type, or of the installation of its lighting or light-signalling devices, or of the list referred to in paragraph 3.2.2. above, shall be notified to the administrative department which approved that vehicle type. The department may then either:
- 7.1.1. Consider that the modifications made are unlikely to have an appreciable adverse effect and that in any case the vehicle still meets the requirements; or
- 7.1.2. Require a further test report from the technical services responsible for conducting the tests.
- 7.2. Confirmation of extension or refusal of approval, specifying the alteration, shall be communicated by the procedure specified in paragraph 4.3. above to the Parties to the Agreement applying this Regulation.

7.3. The competent authority issuing the extension of approval shall assign a series number for such an extension and inform thereof the other Parties to the 1958 Agreement applying this Regulation by means of a communication form conforming to the model in Annex 1 to this Regulation.

8. CONFORMITY OF PRODUCTION

The conformity of production procedures shall comply with those set out in the Agreement, Appendix 2 (E/ECE/324-E/ECE/TRANS/505/Rev.2), with the following requirements:

8.1. Any vehicle approved pursuant to this Regulation shall be so manufactured as to conform to the type approved by meeting the requirements set out in paragraphs 5 and 6 above.

8.2. The holder of the approval shall in particular:

8.2.1. ensure existence of procedures for effective quality control of the vehicle as regards all aspects relevant to compliance with the requirements set out in paragraphs 5 and 6 above;

8.2.2. ensure that for each type of vehicle at least the tests prescribed in Annex 9 to this Regulation or physical checks from which equivalent data may be derived are carried out;

8.3. The competent authority may carry out any test prescribed in this Regulation. These tests will be on samples selected at random without causing distortion of the manufacturers delivery commitments.

8.4. The competent authority shall strive to obtain a frequency of inspection of once per year. However, this is at the discretion of the competent authority and their confidence in the arrangements for ensuring effective control of the conformity of production. In the case where negative results are recorded, the competent authority shall ensure that all necessary steps are taken to re-establish the conformity of production as rapidly as possible.

9. PENALTIES FOR NON-CONFORMITY OF PRODUCTION

9.1. The approval granted in respect of a type of vehicle pursuant to this Regulation may be withdrawn if the requirements are not complied with or if a vehicle bearing the approval mark does not conform to the type approved.

9.2. If a Party to the Agreement applying this Regulation withdraws an approval it has previously granted, it shall forthwith so notify the other Contracting Parties applying this Regulation by means of a communication form conforming to the model in Annex 1 to this Regulation.

10. PRODUCTION DEFINITELY DISCONTINUED

If the holder of the approval completely ceases to manufacture a type of vehicle approved in accordance with this Regulation, he shall inform the authority which granted the approval. Upon receiving the relevant communication, that authority shall inform thereof the other Parties to the Agreement applying this Regulation by means of a communication form conforming to the model in Annex 1 to this Regulation.

11. NAMES AND ADDRESSES OF TECHNICAL SERVICES RESPONSIBLE FOR CONDUCTING APPROVAL TESTS AND OF ADMINISTRATIVE DEPARTMENTS

The Parties to the 1958 Agreement applying this Regulation shall communicate to the United Nations Secretariat the names and addresses of the technical services responsible for conducting approval tests and of the administrative departments which grant approval and to which forms certifying approval or extension or refusal or withdrawal of approval, issued in other countries, are to be sent.

12. TRANSITIONAL PROVISIONS

12.1. As from the official date of entry into force of the 02 series of amendments, no Contracting Party applying this Regulation shall refuse to grant ECE approval under this Regulation as amended by the 02 series of amendments.

12.2. As from 1 October 2002, Contracting Parties applying this Regulation shall grant ECE approvals only if the vehicle type to be approved meets the requirements of this Regulation as amended by the 02 series of amendments.

12.3. Contracting Parties applying this Regulation shall not refuse to grant extensions of approval to preceding series of amendments to this Regulation.

12.4. Until 1 October 2002, Contracting Parties applying this Regulation shall continue to grant approvals to those types of vehicles which comply with the requirements of this Regulation as amended by the preceding series of amendments.

12.5. ECE approvals granted under this Regulation before 1 October 2002 and all extensions of such approvals, including those to a preceding series of amendments to this Regulation granted subsequently, shall remain valid indefinitely. When the vehicle type approved to the preceding series of amendments meets the requirements of this Regulation as amended by the 02 series of amendments, the Contracting Party which granted the approval shall notify the other Contracting Parties applying this Regulation thereof.

- 12.6. No Contracting Party applying this Regulation shall refuse national type approval of a vehicle type approved to the 02 series of amendments to this Regulation.
- 12.7. Until 1 October 2002, no Contracting Party applying this Regulation shall refuse national type approval of a vehicle type approved to the preceding series of amendments to this Regulation.
- 12.8. From 1 October 2003, Contracting Parties applying this Regulation may refuse first national registration (first entry into service) of a vehicle which does not meet the requirements of the 02 series of amendments to this Regulation.
- 12.9. As from the official date of entry into force of Supplement 5 to the 02 series of amendments no Contracting Party applying this Regulation shall refuse to grant approvals under this Regulation as amended by Supplement 5 to the 02 series of amendments.
- 12.10. As from 36 months after the date of entry into force of Supplement 5 to the 02 series of amendments Contracting Parties applying this Regulation shall grant approvals only if the vehicle type to be approved meets the requirements of this Regulation as amended by Supplement 5 to the 02 series of amendments.
- 12.11. Contracting Parties applying this Regulation shall continue to grant approvals to those vehicle types which comply with the requirements of this Regulation as amended by Supplement 4 to the 02 series of amendments during the 36 months period which follows the official date of entry into force of Supplement 5 to the 02 series of amendments.
- 12.12. Until the United Nations Secretary-General is notified otherwise, Japan declares that in relation to the installation of lighting the light signalling devices, Japan will only be bound by the obligations of the Agreement to which this Regulation is annexed with respect to vehicles of categories M1 and N1.
- 12.13. As from the date of entry into force of Supplement 7 to the 02 series of amendments, no Contracting Party applying this Regulation shall refuse to grant approvals under this Regulation as amended by Supplement 7 to the 02 series of amendments.
- 12.14. As from 30 months after the date of entry into force of Supplement 7 to the 02 series of amendments, Contracting Parties applying this Regulation shall grant ECE approvals only if the vehicle type to be approved meets the requirements of this Regulation as amended by Supplement 7 to the 02 series of amendments.
- 12.15. Contracting Parties applying this Regulation shall not refuse to grant extensions of approvals to the preceding series of amendments to this Regulation, including Supplement 6 to the 02 series of amendments.

- 12.16. ECE approvals granted under this Regulation before the date mentioned in paragraph 12.14. above, including extensions of such approvals, shall remain valid indefinitely.
-

Annex 1

COMMUNICATION

(Maximum format: A4 (210 x 297 mm))



issued by: Name of administration:

.....

concerning: 2/

APPROVAL GRANTED
 APPROVAL EXTENDED
 APPROVAL REFUSED
 APPROVAL WITHDRAWN
 PRODUCTION DEFINITELY DISCONTINUED

of a type of vehicle with regard to the installation of lighting and light- signalling devices, pursuant to Regulation No. 48.

Approval No.

Extension No.

1. Trade name or mark of the vehicle:
2. Manufacturer's name for the type of vehicle:
3. Manufacturer's name and address:.....
4. If applicable, name and address of the manufacturer's representative:
.....
5. Submitted for approval on:
6. Technical service responsible for conducting approval tests:
.....
7. Date of test report:
8. Number of test report:.....
9. Concise description:
Lighting and light-signalling devices on the vehicle:
 - 9.1. Main-beam headlamps : yes/no 2/.....
 - 9.2. Dipped-beam headlamps : yes/no 2/.....
 - 9.3. Front-fog lamps : yes/no 2/.....
 - 9.4. Reversing lamps : yes/no 2/.....
 - 9.5. Front direction-indicators: yes/no 2/.....
 - 9.6. Rear direction-indicators : yes/no 2/.....
 - 9.7. Side direction-indicators: yes/no 2/.....
 - 9.8. Hazard warning signal: yes/no 2/.....

- 9.9. Stop-lamps: yes/no 2/.....
- 9.10. Rear registration plate illuminating device: yes/no 2/.....
- 9.11. Front position lamps: yes/no 2/.....
- 9.12. Rear position lamps: yes/no 2/.....
- 9.13. Rear fog-lamps: yes/no 2/.....
- 9.14. Parking lamps: yes/ no 2/.....
- 9.15. End-outline marker lamps: yes/no 2/.....
- 9.16. Rear retro-reflectors, non-triangular: yes/no 2/.....
- 9.17. Rear retro-reflectors, triangular: yes/no 2/.....
- 9.18. Front retro-reflectors, non-triangular: yes/no 2/.....
- 9.19. Side retro-reflectors, non-triangular: yes/no 2/.....
- 9.20. Side marker lamps: yes/no 2/.....
- 9.21. Daytime running lamps: yes/no 2/.....
- 9.22. Cornering lamps: yes/no 2/" "
- 9.23. Equivalent lamps: yes/no 2/.....
- 9.24. Maximum permissible load in the boot:.....
- 10. Comments
- 10.1. Any comments on movable components:.....
- 10.2. Method used for the definition of the apparent surface: boundary of the illuminating surface 2/ or light-emitting surface 2/
- 10.3. Other comments (valid for right-hand or left-hand drive vehicles):
- 11. Position of the approval mark:.....
- 12. Reason(s) for extension (if applicable):.....
- 13. Approval granted/extended/refused/withdrawn 2/
- 14. Place:
- 15. Date:.....
- 16. Signature:.....
- 17. The following documents, bearing the approval number shown above, are available on request:.....

1/ Distinguishing number of the country which has granted/extended/refused/withdrawn approval (see approval provisions in the Regulation).

2/ Strike out what does not apply, or repeat 'yes' or 'no'.

Annex 2

ARRANGEMENTS OF APPROVAL MARKS
Model A

(See paragraph 4.4. of this Regulation)

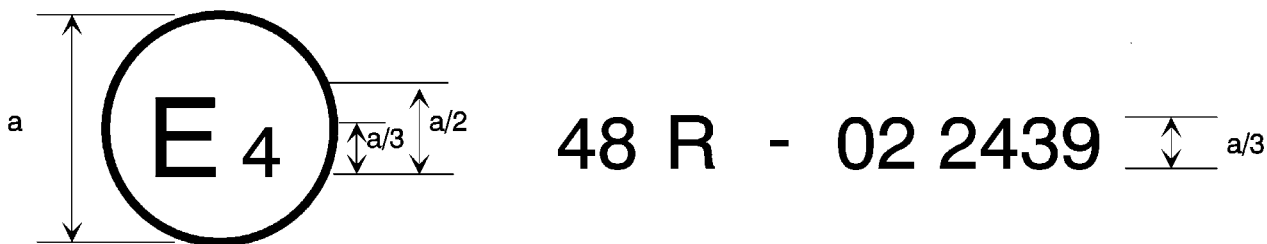

$a = 8 \text{ mm min.}$

The above approval mark affixed to a vehicle shows that the vehicle type concerned has, with regard to the installation of lighting and light-signalling devices, been approved in the Netherlands (E4) pursuant to Regulation No. 48 as amended by the 02 series of amendments. The approval number indicates that the approval was granted in accordance with the requirements of Regulation No. 48 as amended by the 02 series of amendments.

Model B

(see paragraph 4.5. of this Regulation)

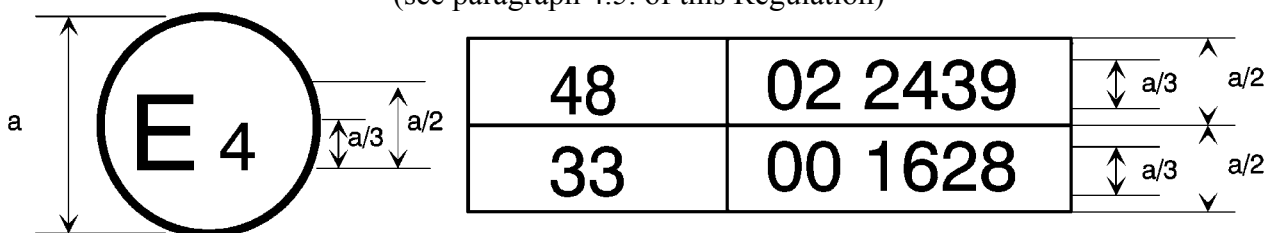

$a = 8 \text{ mm min.}$

The above approval mark affixed to a vehicle shows that the vehicle type concerned has been approved in the Netherlands (E4) pursuant to Regulation No. 48 as amended by the 02 series of amendments and Regulation No. 33. ^{1/} The approval number indicates that, at the dates when the respective approvals were given, Regulation No. 48 was amended by the 02 series of amendments and Regulation No. 33 was still in its original form.

^{1/} The second number is given merely as an example.

Annex 3

LAMP SURFACES, AXIS AND CENTRE OF REFERENCE,
 AND ANGLES OF GEOMETRIC VISIBILITY

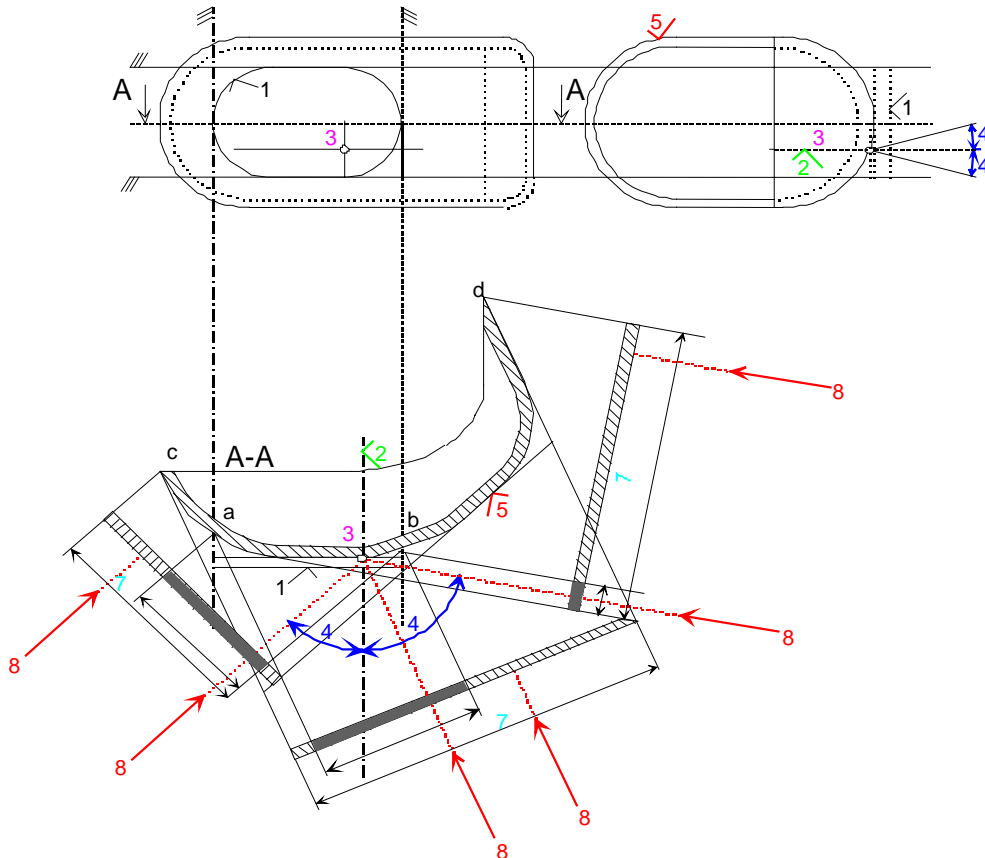

KEY

1. Illuminating surface
2. Axis of reference
3. Centre of reference
4. Angle of geometric visibility
5. Light-emitting surface
6. Apparent surface based on illuminating surface
7. Apparent surface based on light-emitting surface
8. Direction of visibility

Note: Notwithstanding the drawing, the apparent surface is to be considered as tangent to the light-emitting surface.

ILLUMINATING SURFACE IN COMPARISON WITH LIGHT-EMITTING SURFACE

(See paragraphs 2.9. and 2.8. of this Regulation)

SKETCH A

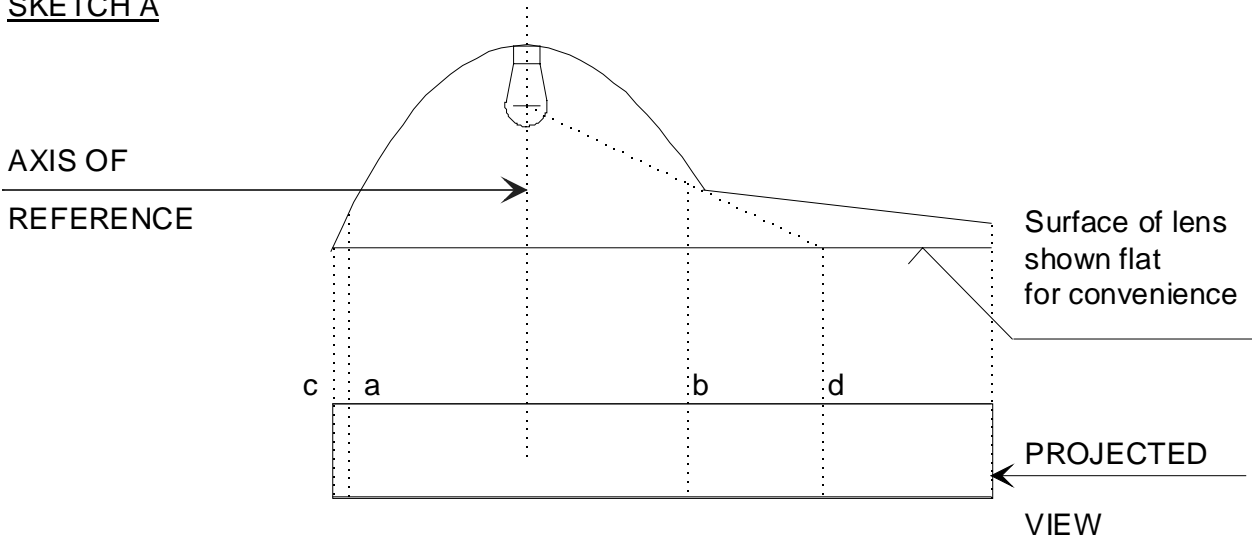

	illuminating surface	Light-emitting surface
Edges are	a and b	c and d

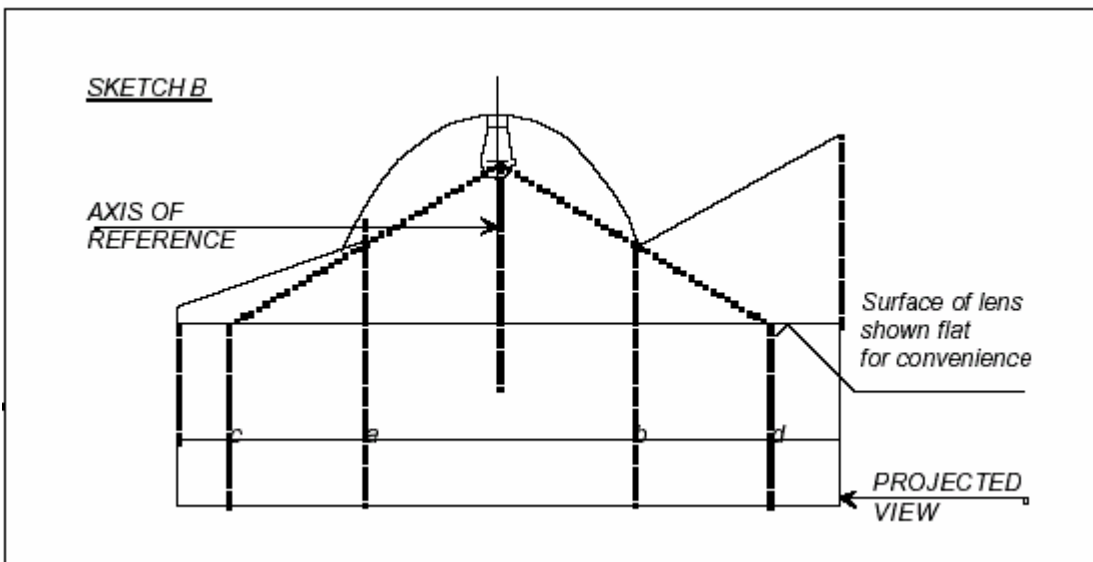

	illuminating surface	Light-emitting surface
Edges are	a and b	c and d

Annex 4

VISIBILITY OF A RED LAMP TO THE FRONT
AND VISIBILITY OF A WHITE LAMP TO THE REAR

(See paragraphs 5.10.1 and 5.10.2 of this Regulation)

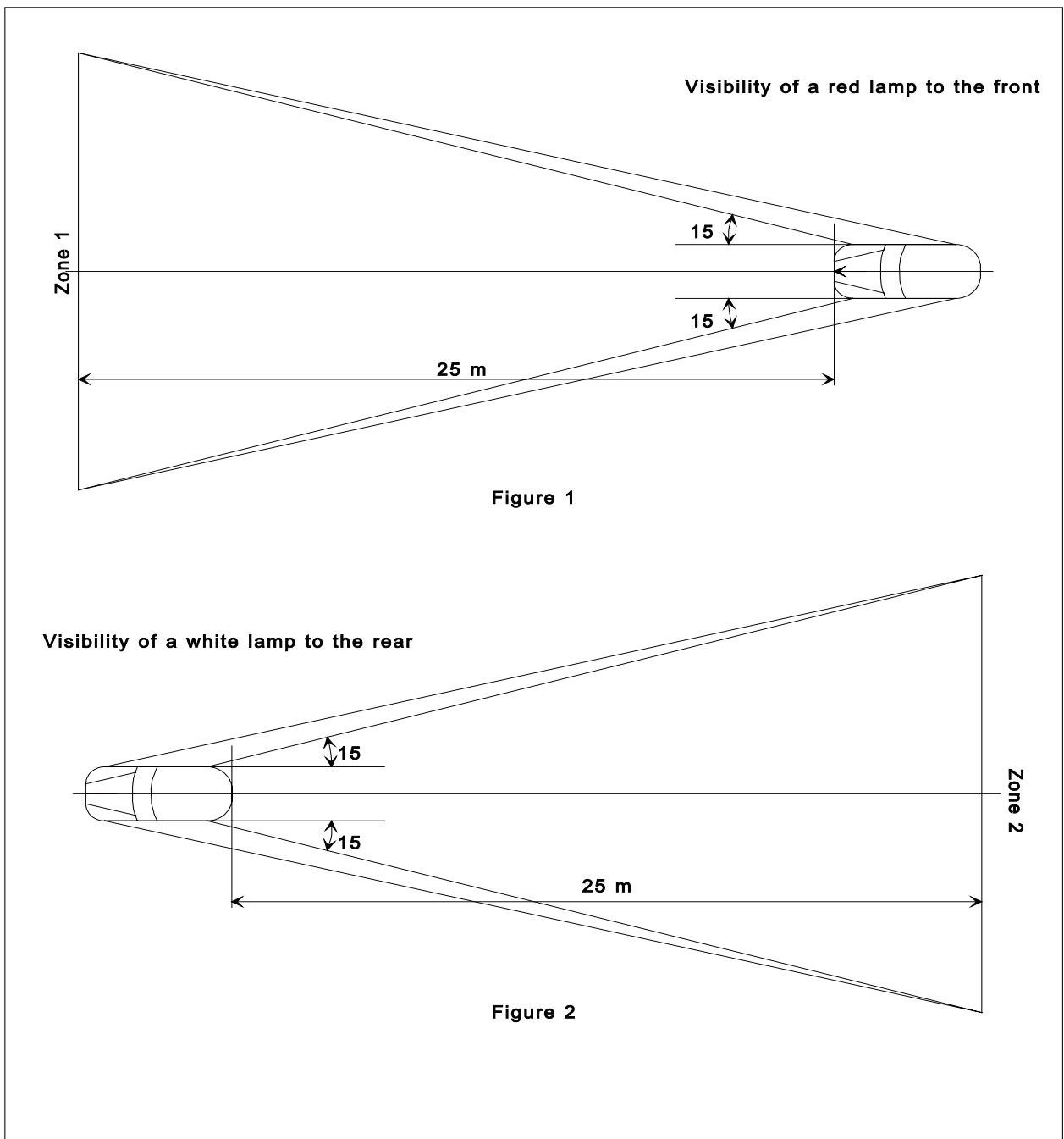

Annex 5

STATES OF LOADING TO BE TAKEN INTO CONSIDERATION IN DETERMINING
VARIATIONS IN THE VERTICAL ORIENTATION OF THE DIPPED-BEAM HEADLAMPS

Loading conditions on axles referred to in paragraphs 6.2.6.1. and 6.2.6.3.1.

1. For the following tests, the mass of the passengers shall be calculated on the basis of 75 kg per person.
2. Loading conditions for different types of vehicles:
 - 2.1. Vehicles in category M1: 1/
 - 2.1.1. The angle of the light beam of the dipped-beam headlamps shall be determined under the following load conditions:
 - 2.1.1.1. one person in the driver's seat;
 - 2.1.1.2. the driver, plus one passenger in the front seat farthest from the driver;
 - 2.1.1.3. the driver, one passenger in the front seat farthest from the driver, all the seats farthest to the rear occupied;
 - 2.1.1.4. all the seats occupied;
 - 2.1.1.5. all the seats occupied, plus an evenly distributed load in the luggage boot, in order to obtain the permissible load on the rear axle or on the front axle if the boot is at the front. If the vehicle has a front and a rear boot, the additional load must be appropriately distributed in order to obtain the permissible axle loads. However, if the maximum permissible laden mass is obtained before the permissible load on one of the axles, the loading of the boot(s) shall be limited to the figure which enables that mass to be reached;
 - 2.1.1.6. driver, plus an evenly distributed load in the boot, in order to obtain the permissible load on the corresponding axle.

However, if the maximum permissible laden mass is obtained before the permissible load on the axle, the loading of the boot(s) shall be limited to the figure which enables that mass to be reached.

1/ As defined in the Consolidated Resolution on the Construction of Vehicles (R.E. 3) Annex 7, (document TRANS/WP.29/78/Rev.1/Amend.2).

- 2.1.2. In determining the above loading conditions, account must be taken of any loading restrictions laid down by the manufacturer.
- 2.2. Vehicles in categories M2 and M3; 1/
- The angle of the light beam from the dipped-beam headlamps must be determined under the following loading conditions:
- 2.2.1. vehicle unladen and one person in the driver's seat;
- 2.2.2. vehicles laden such that each axle carries its maximum technically permissible load or until the maximum permissible mass of the vehicle is attained by loading the front and rear axles proportionally to their maximum technically permissible loads, whichever occurs first.
- 2.3. Vehicles in category N with load surfaces:
- 2.3.1. The angle of the light beam from the dipped-beam headlamps must be determined under the following loading conditions;
- 2.3.1.1. vehicle unladen and one person in the driver's seat;
- 2.3.1.2. driver, plus a load so distributed as to give the maximum technically permissible load on the rear axle or axles, or the maximum permissible mass of the vehicle, whichever occurs first, without exceeding a front axle load calculated as the sum of the front axle load of the unladen vehicle plus 25 per cent of the maximum permissible payload on the front axle. Conversely, the front axle is so considered when the load platform is at the front.
- 2.4. Vehicles in category N without a load surface:
- 2.4.1. Drawing vehicles for semi-trailers:
- 2.4.1.1. Unladen vehicle without a load on the coupling attachment and one person in the driver's seat;
- 2.4.1.2. one person in the driver's seat: technically permissible load on the coupling attachment in the position of the attachment corresponding to the highest load on the rear axle.
- 2.4.2. Drawing vehicles for trailers:

លេខ. 1470-2549

ECE Regulation No. 48

02 series of amendments

page 74

Annex 5

2.4.2.1. vehicle unladen and one person in the driver's seat;

2.4.2.2. one person in the driver's seat, all the other places in the driving cabin being occupied.

Annex 6

MEASUREMENT OF THE VARIATION OF DIPPED-BEAM INCLINATION AS A
FUNCTION OF LOAD

1. Scope

This annex specifies a method for measuring variations in motor vehicle dipped-beam inclination, in relation to its initial inclination, caused by changes in vehicle attitude due to loading.

2. Definitions

2.1. Initial inclination

2.1.1. Stated initial inclination

The value of the dipped-beam initial inclination specified by the motor vehicle manufacturer serving as a reference value for the calculation of permissible variations.

2.1.2. Measured initial inclination

The mean value of dipped-beam inclination or vehicle inclination measured with the vehicle in condition No. 1, as defined in Annex 5, for the category of vehicle under test. It serves as a reference value for the assessment of variations in beam inclination as the load varies.

2.2. Dipped-beam inclination

It may be defined as follows:

either as the angle, expressed in milliradians, between the direction of the beam towards a characteristic point on the horizontal part of the cut-off in the luminous distribution of the headlamp and the horizontal plane,

o r by the tangent of that angle, expressed in percentage inclination, since the angles are small (for these small angles, 1 per cent is equal to 10 mrad).

If the inclination is expressed in percentage inclination, it can be calculated by means of the following formula:

$$\frac{(h_1 - h_2)}{L} \times 100$$

where:

h_1 is the height above the ground, in millimetres, of the above-mentioned characteristic point, measured on a vertical screen perpendicular to the vehicle longitudinal median plane, placed at a horizontal distance L .

h_2 is the height above the ground, in millimetres, of the centre of reference (which is taken to be the nominal origin of the characteristic point chosen in h_1):

L is the distance, in millimetres, from the screen to the centre of reference.

Negative values denote downward inclination (see figure 1).
Positive values denote upward inclination.

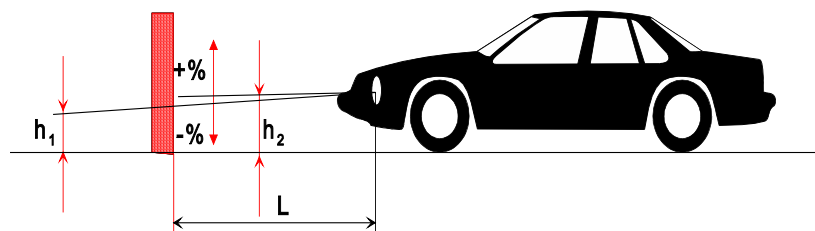

Figure 1

Dipped-beam downward inclination of a category M1 vehicle

Notes:

1. This drawing represents a category M1 vehicle, but the principle shown applies equally to vehicles of other categories.
2. Where the vehicle does not incorporate a headlamp levelling system, the variation in dipped-beam inclination is identical with the variation in the inclination of the vehicle itself.

3. Measurement conditions

- 3.1. If a visual inspection of the dipped-beam pattern on the screen or a photometric method is used, measurement shall be carried out in a dark environment (for example, a dark room) of sufficient area to allow the vehicle and the screen to be placed as shown in Figure 1. Headlamp centres of reference shall be at a distance v from the screen of at least 10 m.
- 3.2. The ground on which measurements are made shall be as flat and horizontal as possible, so that the reproducibility of measurements of dipped-beam inclination can be assured with an accuracy of ± 0.5 mrad (" 0.05 per cent inclination).

3.3. If a screen is used, its marking, position and orientation in relation to the ground and to the median longitudinal plane of the vehicle, shall be such that the reproducibility of the measurement of the dipped-beam inclination can be assured with an accuracy of ± 0.5 mrad (± 0.05 per cent inclination).

3.4. During measurements, the ambient temperature shall be between 10 and 30 °C.

4. Vehicle preparation

4.1. Measurements shall be carried out on a vehicle which has travelled a distance of between 1,000 km and 10,000 km, preferably 5,000 km.

4.2. Tyres shall be inflated to the full-load pressure specified by the vehicle manufacturer. The vehicle shall be fully replenished (fuel, water, oil) and equipped with all the accessories and tools specified by the manufacturer. Full fuel replenishment means that the fuel tank must be filled to not less than 90 per cent of its capacity.

4.3. The vehicle shall have the parking brake released and the gearbox in neutral.

4.4. The vehicle shall be conditioned for at least 8 h at the temperature specified in paragraph 3.4. above.

4.5. If a photometric or visual method is used, headlamps with a well-defined dipped-beam cut-off should preferably be installed on the vehicle under test in order to facilitate the measurements. Other means are allowed to obtain a more precise reading (for example, removal of the headlamp lens).

5. Test procedure

5.1. General

The variations in either dipped-beam or vehicle inclination, depending on the method chosen, shall be measured separately for each side of the vehicle. The results obtained from both left and right headlamps under all the load conditions specified in Annex 5, shall be within the limits set out in paragraph 5.5. below. The load shall be applied gradually without subjecting the vehicle to excessive shocks.

5.2. Determination of the measured initial inclination

The vehicle shall be prepared as specified in paragraph 4 above and laden as specified in Annex 5 (first loading condition of the respective vehicle category). Before each measurement, the vehicle shall be rocked as specified in paragraph 5.4. below. Measurements shall be made three times.

5.2.1. If none of the three measured results differ by more than 2 mrad (0.2 per cent inclination) from the arithmetic mean of the results, that mean shall constitute the final result.

5.2.2. If any measurement differs from the arithmetic mean of the results by more than 2 mrad (0.2 per cent inclination), a further series of 10 measurements shall be made, the arithmetic mean of which shall constitute the final result.

5.3. Measurement methods

Any method may be used to measure variations of inclination provided that the readings are accurate to within ± 0.2 mrad (± 0.02 per cent inclination).

5.4. Treatment of vehicle in each loading condition

The vehicle suspension and any other part likely to affect dipped- beam inclination shall be activated according to the methods described below.

However, the technical authorities and manufacturers may jointly propose other methods (either experimental or based upon calculations), especially when the test poses particular problems, provided such calculations are clearly valid.

5.4.1. M1 category vehicles with conventional suspension

With the vehicle standing on the measuring site and, if necessary, with the wheels resting on floating platforms (which must be used if their absence would lead to restriction of the suspension movement likely to affect the results of measurements), rock the vehicle continuously for at least three complete cycles, for each cycle, first the rear and then the front end of the vehicle is pushed down.

The rocking sequence shall end with the completion of a cycle. Before making the measurements, the vehicle shall be allowed to come to rest spontaneously. Instead of using floating platforms, the same effect can be achieved by moving the vehicle backwards and forwards for at least a complete wheel revolution.

5.4.2. M2, M3 and N category vehicles with conventional suspension

5.4.2.1. If the treatment method for category M1 vehicles described in paragraph 5.4.1. is not possible, the method described in paragraphs 5.4.2.2. or 5.4.2.3. may be used.

5.4.2.2. With the vehicle standing on the measuring site and the wheels on the ground, rock the vehicle by temporarily varying the load.

5.4.2.3. With the vehicle standing on the measuring site and the wheels on the ground, activate the vehicle suspension and all other parts which may affect the

dipped-beam inclination by using a vibration rig. This can be a vibrating platform on which the wheels rest.

- 5.4.3. Vehicles with non-conventional suspension, where the engine has to be running. Before making any measurement wait until the vehicle has assumed its final attitude with the engine running.

5.5. Measurements

The variation of the inclination of the dipped-beam shall be assessed for each of the different loading conditions in relation to the measured initial inclination determined in accordance with paragraph 5.2. above.

If the vehicle is fitted with a manual headlamp-levelling system, the latter shall be adjusted to the positions specified by the manufacturer for given loading conditions (according to Annex 5).

- 5.5.1. To begin with, a single measurement shall be made in each loading condition. Requirements have been met if, for all the loading conditions, the variation in inclination is within the calculated limits (for example, within the difference between the stated initial inclination and the lower and upper limits specified for approval) with a safety margin of 4 mrad (0.4 per cent inclination).
- 5.5.2. If the result(s) of any measurement(s) does (do) not lie within the safety margin indicated in paragraph 5.5.1. or exceed(s) the limit values, a further three measurements shall be made in the loading conditions corresponding to this (these) result(s) as specified in paragraph 5.5.3.
- 5.5.3. For each of the above loading conditions:
- 5.5.3.1. If none of the three measured results differs by more than 2 mrad (0.2 per cent inclination) from the arithmetic mean of the results, that mean shall constitute the final result.
- 5.5.3.2. If any measurement differs from the arithmetic mean of the results by more than 2 mrad (0.2 per cent inclination), a further series of 10 measurements shall be made, the arithmetic mean of which shall constitute the final result.
- 5.5.3.3. If a vehicle is fitted with an automatic headlamp-levelling system which has an inherent hysteresis loop, average results at the top and bottom of the hysteresis loop shall be taken as significant values.

All these measurements shall be made in accordance with paragraphs 5.5.3.1. and 5.5.3.2.

- 5.5.4. Requirements have been met, if, under all loading conditions, the variation between the measured initial inclination determined in accordance with paragraph 5.2. and the inclination measured under each loading condition is less than the values calculated in paragraph 5.5.1. (without safety margin).
- 5.5.5. If only one of the calculated upper or lower limits of variation is exceeded, the manufacturer shall be permitted to choose a different value for the stated initial inclination, within the limits specified for approval.
-

Annex 7

INDICATION OF THE STATED INITIAL ADJUSTMENT REFERRED TO IN
PARAGRAPH 6.2.6.1.1. OF THIS REGULATION

Example

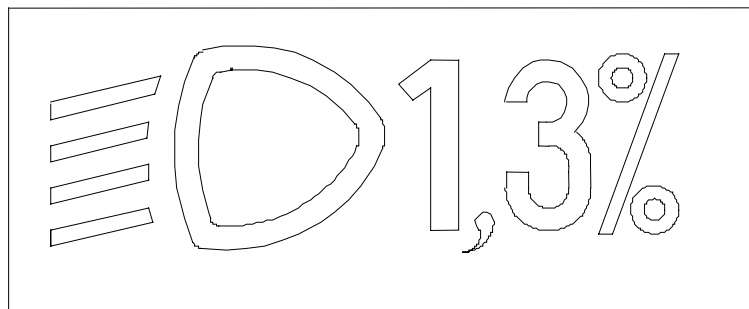

standard symbol for
dipped-beam headlamp

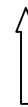

Value of the stated
initial adjustment

The size of the symbol and characters is left to the discretion of the manufacturer.

Annex 8

THE CONTROLS FOR THE HEADLAMP-LEVELLING DEVICES REFERRED TO
IN PARAGRAPH 6.2.6.2.2. OF THIS REGULATION

1. Specifications
 - 1.1. Downward inclination of the dipped-beam must in all cases be produced in one of the following ways:
 - (a) by moving a control downwards or to the left;
 - (b) by rotating a control in a counterclockwise direction;
 - (c) by depressing a button (push-pull control).

If several buttons are used to adjust the beam, the button which gives the greatest downward inclination must be installed to the left or below the button(s) for other dipped-beam positions.

A rotary control which is installed edge-on, or with only the edge visible, should follow the operating principles of control of types (a) or (c).
 - 1.1.1. This control must carry symbols indicating clearly the movements corresponding to the downward and upward inclination of the dipped beam.
 - 1.2. The "O" position corresponds to the initial inclination according to paragraph 6.2.6.1.1. of this Regulation.
 - 1.3. The "O" position which, according to paragraph 6.2.6.2.2. of this Regulation has to be a "stop position", need not necessarily be at the end of the scale.
 - 1.4. The marks used on control must be explained in the owner's handbook.
 - 1.5. Only the following symbols may be used to identify the controls:

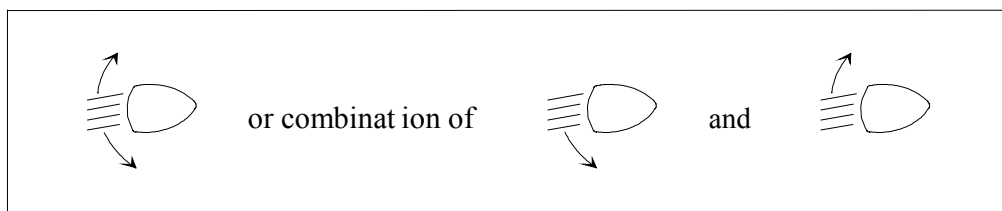

Symbols employing five lines instead of four may also be used
Example 1:

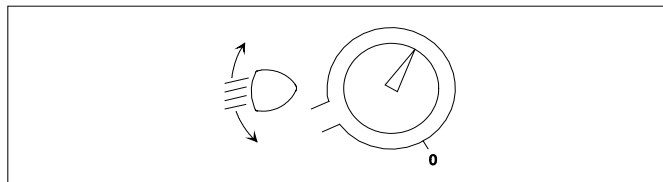

Example 2:

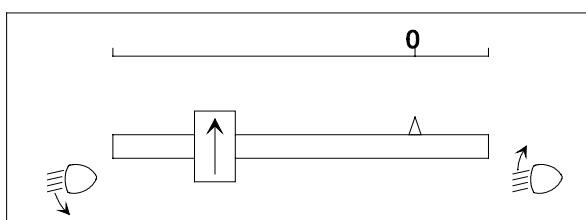

Example 3:

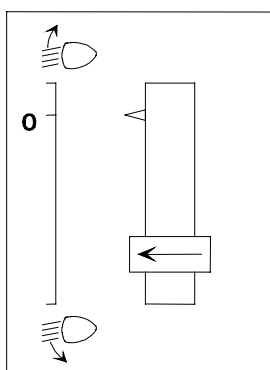

Annex 9

CONTROL OF CONFORMITY OF PRODUCTION

1. TESTS

1.1. Position of lamps

The position of lamps, as defined in paragraph 2.7. of this Regulation, in width, in height and in length shall be checked in accordance with the general requirements set out in paragraphs 2.8. to 2.10., 2.14. and 5.4. of this Regulation

The values measured for the distances shall be such that the individual specifications applicable to each lamp are fulfilled.

1.2. Visibility of lamps

1.2.1. The angles of geometric visibility shall be checked in accordance with paragraph 2.13. of this Regulation.

The values measured for the angles shall be such that the individual specifications applicable to each lamp are fulfilled except that the limits of the angles may have an allowance corresponding to the " 3E variation permitted in paragraph 5.3. for the mounting of the light-signalling devices.

1.2.2. The visibility of red light towards the front and of white light towards the rear shall be checked in accordance with paragraph 5.10. of this Regulation.

1.3. Alignment of dipped-beam headlamps towards the front

1.3.1. Initial downward inclination

The initial downward inclination of the cut-off of the dipped beam shall be set to the plated figure as required and shown in Annex 7.

Alternatively the manufacturer shall set the initial aim to a figure that is different from the plated figure where it can be shown to be representative of the type approved when tested in accordance with the procedures contained in Annex 6 and in particular paragraph 4.1.

1.3.2. Variation of inclination with load

The variation of the dipped beam downward inclination as a function of the loading conditions specified within this section shall remain within the range.

0.2 % to 2.8 % for headlamp mounting height $h < 0.8$;

0.2 % to 2.8 %	for headlamp mounting height $0.8 \leq h \leq 1.0$; or
0.7 % to 3.3 %	(according to the aiming range chosen by the manufacturer at the approval);
0.7 % to 3.3 %	for headlamp mounting height $1.0 < h \leq 1.2$ m;
1.2 % to 3.8 %	for headlamp mounting height $h > 1.2$ m.

The states of loading to be used shall be as follows, as indicated in Annex 5 of this Regulation, for every system adjusted accordingly.

1.3.2.1. Vehicles in category M1:

Paragraph 2.1.1.1.
Paragraph 2.1.1.6. taking into account
Paragraph 2.1.2.

1.3.2.2. Vehicles in category M2 and M3:

Paragraph 2.2.1.
Paragraph 2.2.2.

1.3.2.3. Vehicles in category N with load surfaces:

Paragraph 2.3.1.1.
Paragraph 2.3.1.2.

1.3.2.4. Vehicles in category N without load surfaces:

1.3.2.4.1. Drawing vehicles for semi-trailers:

Paragraph 2.4.1.1.
Paragraph 2.4.1.2.

1.3.2.4.2. Drawing vehicles for trailers:

Paragraph 2.4.2.1.
Paragraph 2.4.2.2.

1.4. Electrical connections and tell-tales

The electrical connections shall be checked by switching on every lamp supplied by the electrical system of the vehicle.

The lamps and tell-tales shall function in accordance with the provisions set out in paragraphs 5.11. to 5.14. of this Regulation and with the individual specifications applicable to each lamp.

1.5. Light intensities

1.5.1. Main-beam headlamps

The aggregate maximum intensity of the main beam headlamps shall be checked by the procedure described in paragraph 6.1.9.2. of this Regulation. The value obtained shall be such that the requirement in paragraph 6.1.9.1. of this Regulation is fulfilled.

1.6. The presence, number, colour, arrangement and, where applicable, the category of lamps shall be checked by visual inspection of the lamps and their markings.

These shall be such that the requirements set out in paragraphs 5.15. and 5.16. as well as in the individual specifications applicable to each lamp are fulfilled.

Paragraphs 2.16. and 2.16.1., amend to read:

"2.16. "Single and multiple lamps";

2.16.1. "A single lamp" means:

- a) a device or part of a device having one lighting or light-signalling function, one or more light source(s) and one apparent surface in the direction of the reference axis, which may be a continuous surface or composed of two or more distinct parts, or
- b) any assembly of two independent lamps, whether identical or not, having the same function, both approved as type "D" lamp and installed so that the projection of their apparent surfaces in the direction of the reference axis occupies not less than 60 per cent of the smallest quadrilateral circumscribing the projections of the said apparent surfaces in the direction of the reference axis."

Paragraph 5.7., amend to read:

"5.7. Grouped, combined or reciprocally incorporated lamps

5.7.1. Lamps may be grouped, combined or reciprocally incorporated with one another provided that all requirements regarding colour, position, orientation, geometric visibility, electrical connections and other requirements, if any, are fulfilled.

5.7.1.1. However, where stop lamps and direction indicator lamps are grouped, any horizontal or vertical straight line passing through the projections of the apparent surfaces of these functions on a plane perpendicular to the reference axis, shall not intersect more than two borderlines separating adjacent areas of different colour.

5.7.2. Where the apparent surface of a single lamp is composed of two or more distinct parts, it shall satisfy the following requirements:

5.7.2.1. Either the total area of the projection of the distinct parts on a plane tangent to the exterior surface of the transparent material and perpendicular to the reference axis shall occupy not less than 60 per cent of the smallest quadrilateral circumscribing the said projection, or the distance between two adjacent/tangential distinct parts shall not exceed 15 mm when measured perpendicularly to the reference axis."

Paragraph 6.15.2., amend the words "Class IIIA" to read "Class IIIA or Class IIIB".

Paragraph 6.15.7., amend to read:

"6.15.7. Other requirements

The illuminating surface of the retro-reflector may have parts in common with the apparent surface of any other lamp situated at the rear."

Paragraph 6.1.7.1., amend to read:

"6.1.7.1. The main-beam headlamps may be switched on either simultaneously or in pairs. In case the extra two main-beam headlamps are installed, as permitted under paragraph 6.1.2. for vehicles of the category N₃ only, no more than two pairs may be simultaneously lit. For changing over from the dipped to the main beam at least one pair of main-beam headlamps shall be switched on. For changing over from the main-beam to the dipped-beam all main-beam headlamps shall be switched off simultaneously."

№00. 1470—2549

ECE Regulation No. 48

02 series of amendments

Rev.1/Add.47/Rev.3/Corr.4

page 2

Paragraph 5.16.1., replace the reference to paragraphs "6.1. to 6.19." with "6.1. to 6.20."

Paragraphs 6.19.7. and 6.19.8., exist in duplicate, delete superfluous paragraphs, (English only).

Insert a new Annex 10, to read:

"Annex 10

EXAMPLES OF LIGHT SOURCE OPTIONS

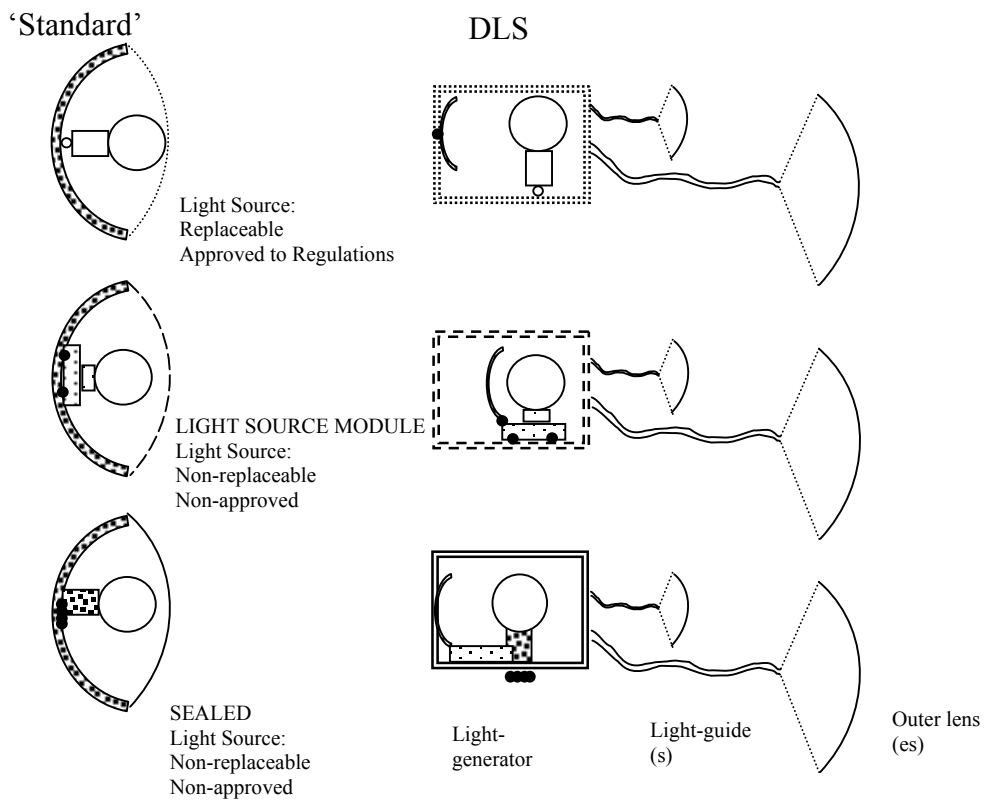

"

暹ร. 1470—2549

ECE Regulation No. 48

02 series of amendments

Rev.1/Add.47/Rev.3/Amend.2

page 2

Paragraph 5.10.1., amend to read:

"5.10.1. For the visibility of red light towards the front of a vehicle, with the exception of a red rearmost side-marker lamp, there must be no direct visibility of the apparent surface of a red lamp if viewed by an observer moving within Zone 1 as specified in Annex 4."

Paragraph 2.7., amend to read:

"2.7. "Lamp" means a device designed to illuminate the road or to emit a light signal to other road users. With the exception of light emitting rear registration plates, rear registration plate lamps and retro-reflectors are likewise to be regarded as lamps;"

Paragraphs 5.17. to 5.21., amend to read:

5.17. Any lamp may be installed on movable components provided that the conditions specified in paragraphs 5.18., 5.19. and 5.20. are fulfilled.

5.18. Rear position lamps, rear direction-indicators and rear retro-reflectors, triangular as well as non triangular, may be installed on movable components only:

5.18.1. - if at all fixed positions of the movable components the lamps on the movable components meet all the position, geometric visibility and photometric requirements for those lamps. Should the above functions be obtained by an assembly of two lamps marked "D" (see paragraph 2.16.1.) only one of these lamps needs to meet the above-mentioned requirements.

or

5.18.2. - where additional lamps for the above functions are fitted and are activated, when the movable component is in any fixed open position, provided that these additional lamps satisfy all the position, geometric visibility and photometric requirements applicable to the lamps installed on the movable component.

5.19. When the movable components are in a position other than a "Normal position of use", the devices installed on them shall not cause undue discomfort to road users.

5.20. When a lamp is installed on a movable component and the movable component is in the "normal position(s) of use", the lamp must always return to the position(s) specified by the manufacturer in accordance with this Regulation. In the case of dipped-beam headlamps and front fog lamps, this requirement shall be considered satisfied if, when the movable components are moved and returned to the normal position 10 times, no value of the angular inclination of these lamps, relative to its support, measured after each operation of the movable component, differs by more than 0.15 per cent from the average of the 10 measured values. If this value is exceeded each limit specified in paragraph 6.2.6.1.1. shall then be modified by this excess to decrease the allowed range of inclinations when checking the vehicle according to Annex 6.

5.21. The apparent surface in the direction of the reference axis of front and rear position lamps, front and rear direction-indicator lamps and retro-reflectors shall not be hidden more than 50 per cent by any movable component, with or without a light-signalling device installed on it, in any fixed position different from the "normal position of use".

If the above requirement is not practicable:

5.21.1. additional lamps satisfying all the position, geometric visibility and photometric requirements for the above indicated lamps shall be activated when the apparent surface in the direction of the reference axis of these lamps is more than 50 per cent hidden by the movable component

or

5.21.2. - a remark in the communication form (item 10.1. of Annex 1) shall inform other Administrations that more than 50 per cent of the apparent surface in the direction of the reference axis can be hidden by the movable components;

and

- a notice in the vehicle shall inform the user that in certain position(s) of the movable components other road users shall be warned of the presence of the vehicle on the road; for example by means of a warning triangle or other devices according to national requirements for use on the road."

Insert a new paragraph 5.21.3., to read:

"5.21.3. Paragraph 5.21.2. does not apply to retro-reflectors."

Paragraph 6.9.9., amend to read:

"6.9.9. Other requirements

If one or more infrared radiation generator(s) is (are) installed inside the front position lamp, it (they) is (are) allowed to be activated only when the headlamp on the same side of the vehicle is switched on and the vehicle is in forward motion. In the event that the front position lamp or the headlamp on the same side fails, the infrared radiation generator(s) shall be automatically switched off."

Paragraph 2.7.12., amend to read:

"2.7.12. "Stop lamp" means a lamp used to indicate to other road users to the rear of the vehicle that the longitudinal movement of the vehicle is intentionally retarded."

Paragraph 6.7.7., amend to read:

"6.7.7. Electrical connections

6.7.7.1. All stop lamps must light up simultaneously when the braking system provides the relevant signal defined in Regulations Nos. 13 and 13-H.

6.7.7.2. The stop lamps need not function if the device, which starts and/or stops the engine, is in a position that makes it impossible for the engine to operate."
